

RICOH

SLR Digital Camera

PENTAX *K-S2*

Operating Manual

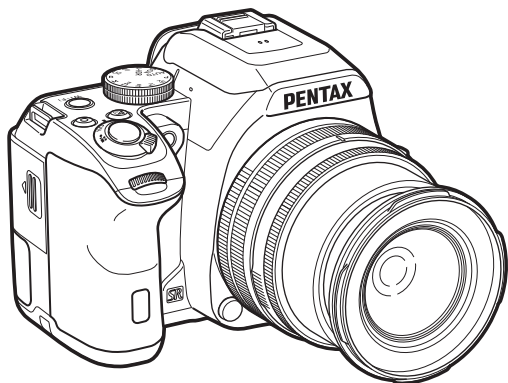

Introduction **1**

Getting Started **2**

Shooting **3**

Playback **4**

Sharing **5**

Settings **6**

Appendix **7**

To ensure the best performance from your camera, please read the Operating Manual before using the camera.

Checking the Contents of the Package



Hot shoe cover Fk
(Installed on camera)

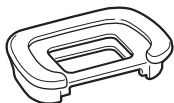

Eyecup Fr
(Installed on camera)

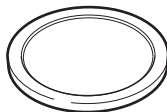

Body mount cover
(Installed on camera)

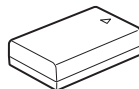

Rechargeable Lithium-ion
Battery D-LI109

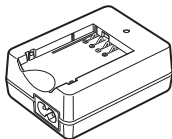

Battery charger
D-BC109



AC plug cord

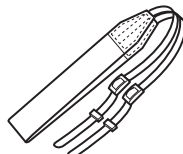

Strap
O-ST132

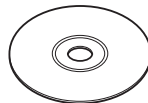

Software (CD-ROM)
S-SW156



Start Guide

Lenses you can use

Lenses that can be used with this camera are DA, DA L, D FA and FA J lenses and lenses that have an **A** (Auto) position on the aperture ring. To use any other lens or accessory, see p.113.

Introducing the K-S2

1

Getting Started

2

Taking Pictures

3

Playback Functions

4

Sharing Images

5

Changing the Settings

6

Appendix

7

How to Use This Manual

1

Introducing the K-S2.....p.7

Gives you an overview of the K-S2.
Read this and get to know your K-S2!

- Names and Functions of the Working Parts**p.7
- How to Change Function Settings**p.18
- Menu List**p.21

2

Getting Started.....p.30

Explains how to get your K-S2 ready for shooting as well as basic operations.

- Attaching the Strap**p.30
- Attaching a Lens**p.30
- Using the Battery and Charger**p.31
- Inserting a Memory Card**p.34
- How to Open the Monitor**p.35
- Initial Settings**p.36

- Basic Shooting Operation**p.39
- Reviewing Images**p.42

3

Taking Pictures.....p.44

Once you've confirmed that the camera works properly, try out the camera and take lots of pictures!

- Configuring the Capture Settings**p.44
- Taking Still Pictures**p.45
- Recording Movies**p.49
- Setting the Exposure**p.51
- Using the Built-in Flash**p.53
- Setting the Focus Method**p.54
- Setting the Drive Mode**p.59
- Setting the White Balance**p.68
- Controlling the Image Finishing Tone**p.71
- Correcting Images**p.74

4

Playback Functionsp.77

Explains various operations for playing back and editing images.

- Playback Mode Palette Items** p.77
- Changing the Playback Method** p.78
- Connecting the Camera to a Computer** p.82
- Editing and Processing Images** p.83

5

Sharing Images.....p.89

Explains how to share images with other devices using the built-in Wi-Fi function.

- Enabling the Wi-Fi Function** p.89
- Operating the Camera with a Communication Device** p.91

6

Changing the Settingsp.100

Explains how to change other settings.

- Camera Settings** p.100
- File Management Settings** p.106

7

Appendix.....p.110

Provides other resources to get the most from your K-S2.

- Restrictions on Each Capture Mode** p.110
- Functions Available with Various Lenses** p.113
- Functions when Using an External Flash** p.116
- Using the GPS Unit** p.117
- Troubleshooting** p.118
- Main Specifications** p.123
- Index** p.130
- For Using Your Camera Safely** p.135
- Care to be Taken During Handling** p.137
- WARRANTY POLICY** p.141

There is a possibility that the illustrations and the display screen of the monitor in this manual are different from the actual ones.

Contents

How to Use This Manual	2
-------------------------------------	----------

Introducing the K-S2	7
-----------------------------------	----------

Names and Functions of the Working Parts

Operating Controls	8
Monitor	10
Viewfinder	16
Electronic Level	17

How to Change Function Settings

Using the Direct Keys	18
Using the Control Panel	18
Using the Menus	19

Menu List

Rec. Mode Menus	21
Movie Menu	25
Playback Menu	25
Set-up Menus	26
Custom Setting Menus	28

Getting Started	30
------------------------------	-----------

Attaching the Strap	30
----------------------------------	-----------

Attaching a Lens	30
-------------------------------	-----------

Using the Battery and Charger	31
--	-----------

Charging the Battery	31
Inserting/Removing the Battery	32
Using the AC Adapter	33

Inserting a Memory Card	34
--------------------------------------	-----------

How to Open the Monitor	35
--------------------------------------	-----------

Initial Settings	36
-------------------------------	-----------

Turning the Camera On	36
Setting the Display Language	37
Setting the Date and Time	37
Setting the LCD Display	38
Formatting a Memory Card	38

Basic Shooting Operation

Shooting with the Viewfinder	39
Shooting While Viewing the Live View Image	41

Reviewing Images

Taking Pictures	44
------------------------------	-----------

Configuring the Capture Settings

Image Capture Settings	44
Movie Capture Settings	44

Taking Still Pictures

Scene Modes	45
Advanced HDR Mode	46
Exposure Modes	47
EV Compensation	48

Recording Movies

Playing Back Movies	51
---------------------------	----

Setting the Exposure

Sensitivity	51
AE Metering	52

Using the Built-in Flash

Setting the Focus Method

Setting the AF Mode when Shooting with the Viewfinder	55
---	----

Setting the AF Mode during Live View	57	Connecting the Camera to an AV Device	81
AF Fine Adjustment	58	Connecting the Camera to a Computer	82
Setting the Drive Mode	59	Editing and Processing Images	83
Continuous Shooting	60	Changing the Image Size	83
Self-timer	60	Correcting Color Moiré	84
Remote Control	61	Processing Images with Digital Filters	84
Bracketing	62	Editing Movies	86
Multi-exposure	63	Developing RAW Images	87
Interval Shooting	64	Sharing Images	89
Interval Composite	65	Enabling the Wi-Fi Function	89
Interval Movie Record	66	Setting from the Menu	89
Star Stream	67	Pressing the Self-portrait Shutter Button	90
Setting the White Balance	68	Touching a Communication Device	90
Adjusting the White Balance Manually	70	Operating the Camera with a Communication	
Adjusting the White Balance with Color		Device	91
Temperature	70	Connecting the Camera and Communication Device	91
Controlling the Image Finishing Tone	71	Screens of "Image Sync"	93
Custom Image	71	Shooting with a Communication Device	94
Digital Filter	73	Viewing Images	95
Correcting Images	74	Changing the Settings	98
Brightness Adjustment	74	Changing the Settings	100
Lens Correction	75	Camera Settings	100
Anti-Aliasing Filter Simulator	76	Customizing the Button/E-dial Functions	100
Texture Enhancement	76	Saving Frequently Used Settings	103
Playback Functions	77	Displaying the Local Date and Time of the Specified	
Playback Mode Palette Items	77	City	105
Changing the Playback Method	78	Selecting Settings to Save in the Camera	105
Displaying Multiple Images	78	File Management Settings	106
Displaying Images by Folder	79	Protecting Images from Deletion (Protect)	106
Displaying Images by Shooting Date	79	Selecting the Folder/File Settings	106
Playing Back Images Continuously (Slideshow)	80	Setting the Copyright Information	109
Displaying Rotated Images	80		

Appendix	110
Restrictions on Each Capture Mode	110
Restrictions on the Combinations of Special Functions	112
Functions Available with Various Lenses	113
Using the Aperture Ring	115
Setting the Focal Length	116
Functions when Using an External Flash	116
Using the GPS Unit	117
Shooting Celestial Bodies (ASTROTRACER)	118
Troubleshooting	118
Sensor Cleaning	120
Error Messages	121
Main Specifications	123
Operating Environment for USB Connection and Provided Software	129
Index	130
For Using Your Camera Safely	135
Care to be Taken During Handling	137
WARRANTY POLICY	141

Regarding copyrights

Images taken with this camera that are for anything other than personal enjoyment cannot be used without permission according to the rights as specified in the Copyright Act. Please take care, as there are cases where limitations are placed on taking pictures even for personal enjoyment during demonstrations, performances or of items on display. Images taken with the purpose of obtaining copyrights also cannot be used outside the scope of use of the copyright as laid out in the Copyright Act, and care should be taken here also.

To users of this camera

- Do not use or store this camera in the vicinity of equipment that generates strong electromagnetic radiation or magnetic fields. Strong static charges or the magnetic fields produced by equipment such as radio transmitters could interfere with the monitor, damage the stored data, or affect the camera's internal circuitry and cause camera misoperation.
- The liquid crystal panel used for the monitor is manufactured using extremely high precision technology. Although the level of functioning pixels is 99.99% or better, you should be aware that 0.01% or fewer of the pixels may not illuminate or may illuminate when they should not. However, this has no effect on the recorded image.
- In this manual, the generic term "computer(s)" refers to either a Windows PC or a Macintosh.
- In this manual, the term "battery(ies)" refers to any type of batteries used for this camera and its accessories.

Regarding User Registration

In order to better serve you, we request that you complete the user registration, which can be found on the CD-ROM supplied with the camera or on our website.

Thank you for your cooperation.





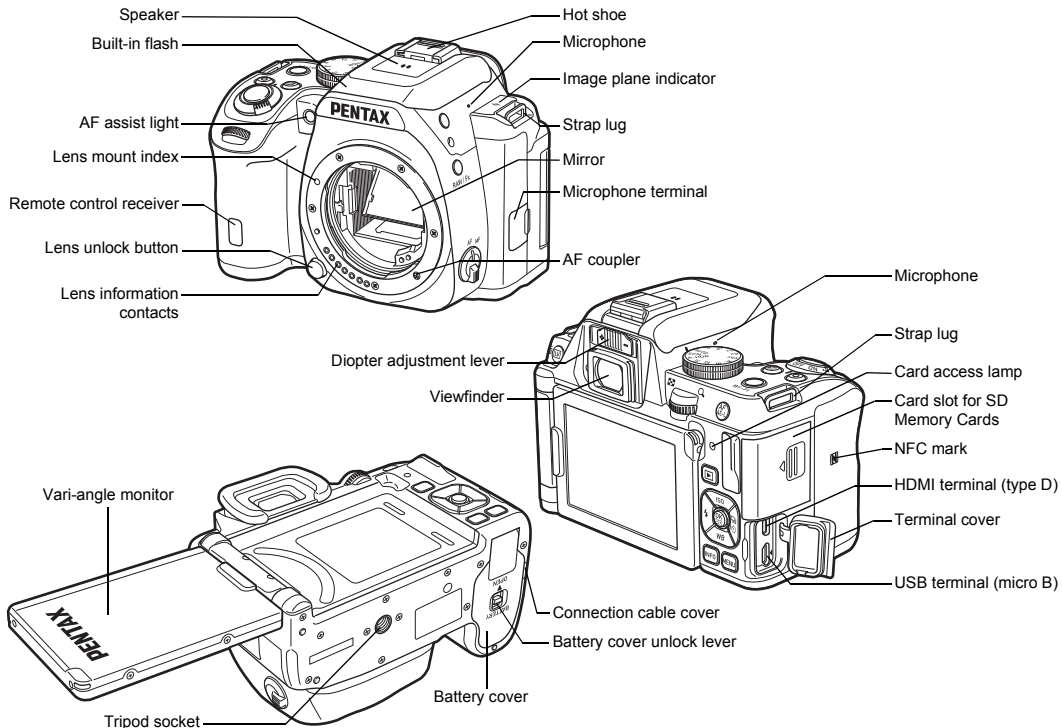



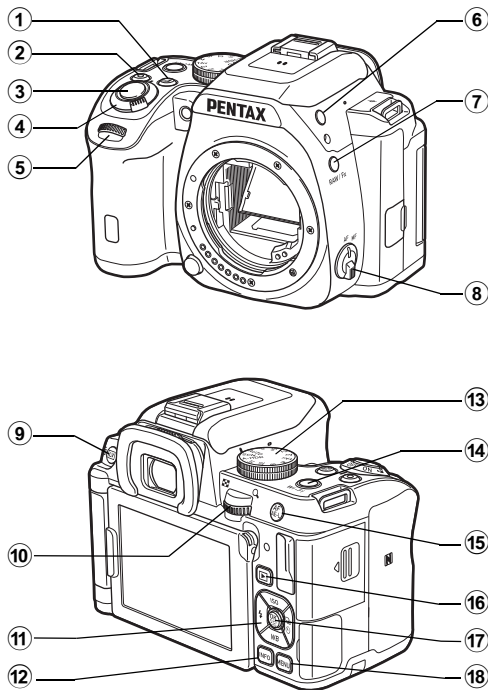

<http://www.ricoh-imaging.com/registration/>













Names and Functions of the Working Parts



Operating Controls



- ① **EV Compensation button** ()
Press to change the exposure compensation value. (p.48)
In playback mode, the last JPEG image taken can also be saved in RAW format. (p.43)
- ② **Green button** ()
Resets the value being adjusted.
- ③ **Shutter release button** ()
Press to capture images. (p.40)
In playback mode, press halfway to switch to capture mode.
- ④ **Main switch**
Turns the power on/off, or switches to  (movie) mode. (p.36, p.49)
When the camera is turned on, it enters  (still picture) mode and the indicator lamp lights green. When the switch is turned to , the camera enters  mode and the lamp lights red.
- ⑤ **Front e-dial** ()
Changes the values for camera settings such as exposure. (p.47)
You can change the menu category when a menu screen is displayed. (p.19)
In playback mode, use this to select a different image.
- ⑥ **Flash pop-up button** ()
Press to pop up the built-in flash. (p.53)
- ⑦ **RAW/Fx button** ()
You can assign a function to this button. (p.100)
- ⑧ **Focus mode switch**
Changes the focus mode. (p.54)
- ⑨ **Live View/Delete button** ()
Displays the Live View image. (p.41)
In playback mode, press to delete images. (p.43)

- 10 Rear e-dial** 
Changes the values for camera settings such as exposure. (p.47)
You can change the menu tabs when a menu screen is displayed. (p.19)
You can change the camera settings when the control panel is displayed. (p.18)
In playback mode, use this to magnify an image or display multiple images at the same time. (p.43, p.78)
- 11 Four-way controller** 
Displays the Sensitivity, White Balance, Flash Mode or Drive Mode setup menu. (p.18)
When a menu or the control panel is displayed, use this to move the cursor or change the item to set.
Press  in single image display of the playback mode to display the playback mode palette. (p.77)
- 12 INFO button** 
Changes the style of the display on the monitor. (p.10, p.14)
- 13 Mode dial**
Changes the capture mode. (p.39)
- 14 Self-portrait shutter button**
When shooting with Live View, this button can be used as a shutter release button and facilitates taking self-portraits by holding the camera with the lens facing you. The indicator lamp lights green or red when the button can be used as a shutter release button. (p.41)
At all other times, this button is used to switch the Wi-Fi function on or off. (p.90)
- 15 AF/AE Lock button** 
Available for adjusting focus, instead of pressing  halfway, and for locking the exposure value before shooting. (p.54, p.101)
- 16 Playback button** 
Switches to playback mode. (p.42)
Press the button again to switch to capture mode.
- 17 OK button** 
When a menu or the control panel is displayed, press this button to confirm the selected item.
Press this button when [AF Active Area] is set to  or , or when [Contrast AF] is set to  or  to change the focusing area. (p.56, p.57)
When the power is turned on, the indicator lamp lights blue. The lamp turns off after a while.
- 18 MENU button** 
Displays a menu. Press this button while the menu is displayed to return to the previous screen. (p.19)

About the indicator lamps

The main switch lamp, self-portrait shutter button lamp, and **OK** lamp turn off in the following situations.

- From the time when **SHUTTER** is pressed halfway until the end of shooting
 - While **AF/AE-L** is pressed
 - During playback mode
 - While a menu is displayed
 - During Auto Power Off
- You can set the lamp lighting settings in [Indicator Lamps] of the 3 menu. (p.27)

About the four-way controller

In this manual, each button of the four-way controller is indicated as shown in the illustration on the right.

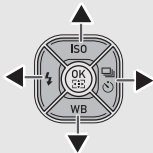

Monitor

Capture Mode

With this camera, you can take pictures while looking through the viewfinder or while viewing the image on the monitor. When using the viewfinder, you can take pictures while checking the status screen displayed on the monitor and looking through the viewfinder. (p.39) When not using the viewfinder, you can take pictures while viewing the Live View image displayed on the monitor. (p.41)

The camera is in “standby mode” when it is ready to shoot, such as when the status screen or Live View image is displayed. Press **INFO** in standby mode to display the “control panel” and change settings. (p.18) You can change the type of information displayed in standby mode by pressing **INFO** while the control panel is displayed. (p.13)

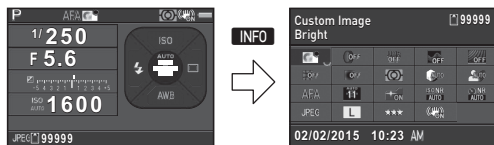

Standby mode
(Status screen)

Control panel



Shooting Info Display
selection screen

Status Screen

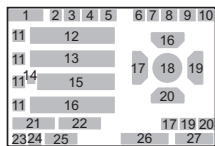
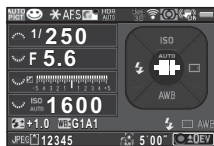

- | | |
|--|---|
| 1 Capture mode (p.45) | 16 Sensitivity (p.51) |
| 2 AE Lock (p.49) | 17 Flash Mode (p.53) |
| 3 Focus Method (p.54) | 18 Focusing area (AF point) (p.56) |
| 4 Custom Image (p.71) | 19 Drive Mode (p.59) |
| 5 Digital Filter (p.73)/HDR Capture (p.74) | 20 White Balance (p.68) |
| 6 GPS positioning status (p.117) | 21 Flash Exposure Compensation (p.53) |
| 7 Wireless LAN status (p.89) | 22 White Balance fine-tuning (p.69) |
| 8 AE Metering (p.52) | 23 File Format (p.44) |
| 9 Shake Reduction/ Horizon Correction (p.22) | 24 Memory card |
| 10 Battery level | 25 Image storage capacity |
| 11 E-dial guide | 26 Number of shots during Multi-exposure, Interval Shooting, or Interval Composite/Maximum tracking duration of ASTROTRACER (p.118) |
| 12 Shutter speed | 27 Operation guide |
| 13 Aperture value | |
| 14 EV Compensation (p.48)/Bracketing (p.62) | |
| 15 EV bar scale | |

Live View

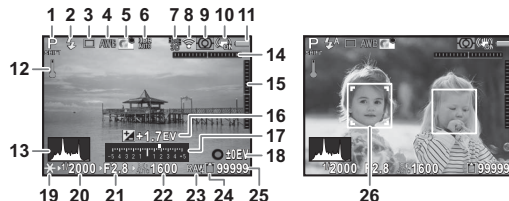

- | | |
|---|--|
| 1 Capture mode (p.45) | 15 Electronic Level (vertical tilt) (p.17) |
| 2 Flash Mode (p.53) | 16 EV Compensation (p.48) |
| 3 Drive Mode (p.59) | 17 EV bar scale |
| 4 White Balance (p.68) | 18 Operation guide, and number of shots during Multi-exposure, Interval Shooting or Interval Composite |
| 5 Custom Image (p.71) | 19 AE Lock (p.49) |
| 6 Digital Filter (p.73)/HDR Capture (p.74) | 20 Shutter speed |
| 7 GPS positioning status (p.117) | 21 Aperture value |
| 8 Wireless LAN status (p.89) | 22 Sensitivity (p.51) |
| 9 AE Metering (p.52) | 23 File Format (p.44) |
| 10 Shake Reduction/ Horizon Correction (p.22)/Movie SR (p.25) | 24 Memory card |
| 11 Battery level | 25 Image storage capacity |
| 12 Temperature warning | 26 Face detection frame (when [Contrast AF] is set to [Face Detection]) (p.57) |
| 13 Histogram | |
| 14 Electronic Level (horizontal tilt) (p.17) | |

Memo

- In [Live View] of the menu, you can change the settings of the items displayed on the monitor during Live View. (p.22)

Control Panel

mode

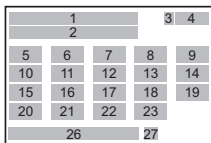
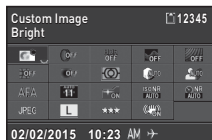

When shooting with Live View

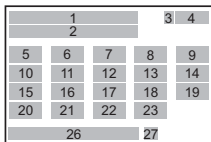
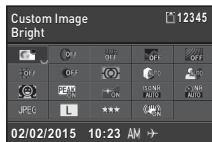

mode

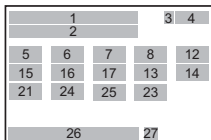
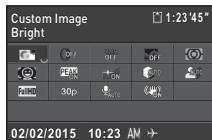

- 1 Function name
- 2 Setting
- 3 Memory card
- 4 Number of recordable still pictures/Movie recordable time
- 5 Custom Image (p.71)/ Scene Mode (p.45)
- 6 Digital Filter (p.73)
- 7 HDR Capture (p.74)
- 8 Clarity Enhancement (p.76)
- 9 AA Filter Simulator (p.76)
- 10 Distortion Correction (p.75)
- 11 Peripheral Illumination Correction (p.75)
- 12 AE Metering (p.52)

- 13 Highlight Correction (p.74)
- 14 Shadow Correction (p.74)
- 15 AF Mode (p.55)/Contrast AF (p.57)
- 16 AF Active Area (p.56)/ Focus Peaking (p.57)
- 17 AF Assist Light (p.55)
- 18 High-ISO NR (p.52)
- 19 Slow Shutter Speed NR (p.48)
- 20 File Format (p.44)
- 21 JPEG Recorded Pixels (p.44)/Movie Recorded Pixels (p.44)
- 22 JPEG Quality (p.44)
- 23 Shake Reduction (p.22)/ Movie SR (p.25)
- 24 Framerate (p.44)
- 25 Recording Sound Level (p.50)
- 26 Current date and time
- 27 Destination (p.105)

Memo

- The items that can be selected vary depending on the current camera setup.
- If no operations are made within 1 minute while the control panel is displayed, the camera returns to standby mode.

Shooting Info Display

You can change the type of information displayed in standby mode by pressing **INFO** while the control panel is displayed. Use **◀▶** to select the type and press **OK**.

When shooting with the viewfinder

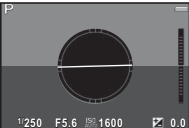
Status Screen	Displays the settings for shooting with the viewfinder. (p.11)
Electronic Level	<p>Displays the camera angle. A scale indicating the horizontal camera angle appears at the center of the screen, and a scale indicating the vertical camera angle appears on the right or left side. When the angle exceeds the range that can be displayed in the scale, the indicators on the scale are displayed in red.</p>  <p>Example: Tilted 1.5° to the left (yellow) Vertically level (green)</p>
Display Off	Nothing is displayed on the monitor.
Electronic Compass	<p>The current latitude, longitude, altitude, direction, Coordinated Universal Time (UTC), capture mode, and exposure value are displayed. Turn the camera off and on again to return to the status screen.</p> <p>Available only when the optional GPS unit is attached to the camera and is operating. (p.117)</p>

When shooting with Live View

Standard Information Display	The Live View image and the settings for shooting with Live View are displayed. (p.11)
Electronic Level	The same electronic level as when shooting with the viewfinder is displayed.
No Information Display	Certain icons, such as those for the capture mode and drive mode, are not displayed.

Memo

- The status screen is displayed when the camera is turned off and on again. If [Shooting Info Display] is set to [On] in [Memory] of the **4** menu, the screen selected on the Shooting Info Display selection screen appears when the camera is turned off and on again. (p.105)

Playback Mode

The captured image and shooting information are displayed in single image display of the playback mode.

Press **INFO** to change the type of information displayed in single image display. Use **◀▶** to select the type and press **OK**.



Single image display
(Standard Information
Display)



Playback Info Display
selection screen

Standard Information Display	Captured image, file format, exposure parameters, and operation guide indicators are displayed.
Detailed Information Display	Detailed information on how and when the image was taken is displayed. (p.14)
Histogram Display	Captured image and brightness histogram are displayed. (p.15) Not available during movie playback.
RGB Histogram Display	Captured image and RGB histogram are displayed. (p.15) Not available during movie playback.
No Information Display	Only the captured image is displayed.

Memo

- The screen selected in the Playback Info Display selection screen is displayed in playback mode when the camera is turned off and on again. If [Playback Info Display] is set to [Off] in [Memory] of the **4** menu, the [Standard Information Display] always appears first when the camera is turned on. (p.105)

Detailed Information Display

Still pictures

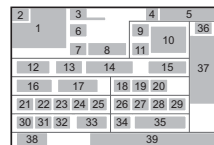

Movies

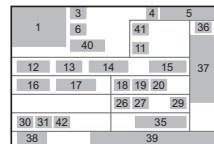

Page 2

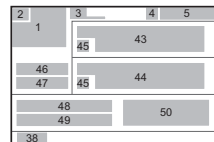

- Captured image
- Rotation information (p.80)
- Capture mode (p.45)
- Protect setting (p.106)
- Folder number-File number (p.106)
- Drive Mode (p.59)
- Flash Mode (p.53)
- Flash Exposure Compensation (p.53)
- Focus Method (p.54)
- Focusing area (AF point) (p.56)

- 11 AE Metering (p.52)
- 12 Shutter speed
- 13 Aperture value
- 14 Sensitivity (p.51)
- 15 EV Compensation (p.48)
- 16 White Balance (p.68)
- 17 White Balance fine-tuning (p.69)
- 18 Digital Filter (p.73)
- 19 HDR Capture (p.74)
- 20 Clarity Enhancement (p.76)
- 21 Distortion Correction (p.75)
- 22 Peripheral Illumination Correction (p.75)
- 23 Lateral Chromatic Aberration Adjustment (p.75)
- 24 Diffraction Correction (p.75)
- 25 Color Fringe Correction (p.87)
- 26 Highlight Correction (p.74)
- 27 Shadow Correction (p.74)
- 28 AA Filter Simulator (p.76)
- 29 Shake Reduction/ Horizon Correction (p.22)/Movie SR (p.25)
- 30 File Format (p.44)
- 31 JPEG Recorded Pixels (p.44)/Movie Recorded Pixels (p.44)
- 32 JPEG Quality (p.44)
- 33 Color Space (p.29)
- 34 Color Moiré Correction (p.84)
- 35 Lens focal length
- 36 Custom Image setting (p.71)
- 37 Custom Image parameters
- 38 Page guide
- 39 Shooting date and time
- 40 Length of time of the recorded movie
- 41 Recording Sound Level
- 42 Framerate (p.44)
- 43 Photographer (p.109)
- 44 Copyright Holder (p.109)
- 45 Information tampering warning
- 46 Altitude (p.117)
- 47 Lens direction (p.117)
- 48 Latitude (p.117)
- 49 Longitude (p.117)
- 50 Universal Coordinated Time (p.117)

Histogram Display

Use ▲▼ to switch between the brightness histogram and RGB histogram.

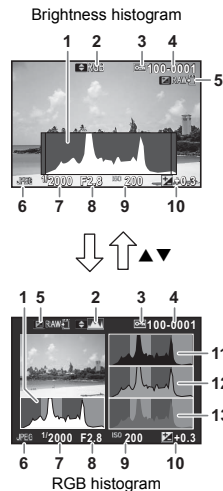

- 1 Histogram (Brightness)
- 2 Switch RGB histogram/ Brightness histogram
- 3 Protect setting
- 4 Folder number-File number
- 5 Save RAW Data
- 6 File Format
- 7 Shutter speed
- 8 Aperture value
- 9 Sensitivity
- 10 EV Compensation
- 11 Histogram (R)
- 12 Histogram (G)
- 13 Histogram (B)

Viewfinder

When shooting with the viewfinder, the following information appears in the viewfinder.

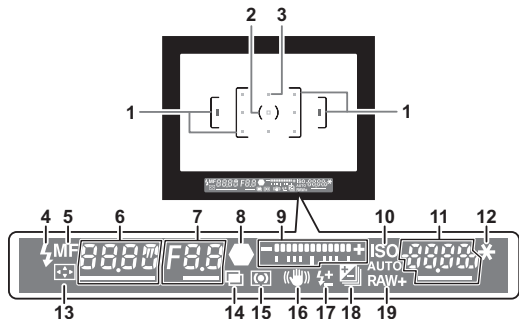

- | | |
|---|--|
| 1 AF frame (p.40) | 11 Sensitivity (p.51)/
Exposure compensation
value |
| 2 Spot metering frame
(p.52) | 12 AE Lock (p.49) |
| 3 AF point (p.56) | 13 Change AF Point (p.56) |
| 4 Flash indicator (p.53) | 14 Multi-exposure (p.63) |
| 5 Focus Method (p.54) | 15 AE Metering (p.52) |
| 6 Shutter speed | 16 Shake Reduction (p.22) |
| 7 Aperture value | 17 Flash Exposure
Compensation (p.53) |
| 8 Focus indicator (p.40) | 18 EV Compensation
(p.48)/Bracketing (p.62) |
| 9 EV bar scale/Electronic
Level (p.17) | 19 File Format (p.44) |
| 10 ISO/ISO AUTO | |

Memo

- The information is displayed in the viewfinder when **SHUTTER** is pressed halfway, or during the meter operating time (default setting: 10 sec.).
- The AF point in use for autofocus appears in red (Superimpose AF Area) when **SHUTTER** is pressed halfway. You can set it to [Off] in [16 Superimpose AF Area] of the **C3** menu.
- You can adjust the image sharpness in the viewfinder using the diopter adjustment lever. If it is difficult to move the diopter adjustment lever, lift up and remove the eyecup. Adjust the diopter setting until the AF frame in the viewfinder looks sharp and clear.

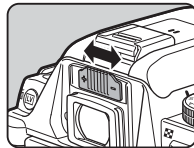

Electronic Level

You can check whether the camera is tilted by displaying the electronic level. The electronic level for the horizontal camera angle can be displayed in the EV bar scale in the viewfinder, and the electronic levels for the vertical and horizontal camera angles can be displayed on the Live View screen. (p.11) Select whether to display the electronic level in [Electronic Level] of the 3 menu. (p.22)

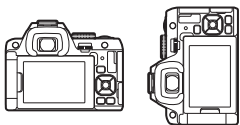

When level (at 0°)



When tilted 5° to the left



When held vertically and tilted 3° to the right



How to Change Function Settings

The camera functions and their settings can be selected and changed by using the following ways.

Direct keys	Press ▲▼◀▶ in standby mode.
Control panel	Press INFO in standby mode. (indicated with the  icon in this manual)
Menus	Press MENU .

Using the Direct Keys

▲	Sensitivity	p.51
▼	White Balance	p.68
◀	Flash Mode	p.53
▶	Drive Mode	p.59

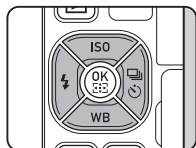



Using the Control Panel

INFO

You can set frequently used shooting functions. Press **INFO** in standby mode.

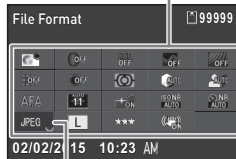
Use **▲▼◀▶** to select an item.



Use  to change settings.

Press **OK** to make detailed settings.

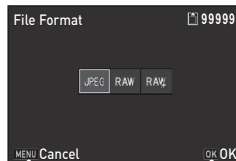



Press **MENU** to cancel the setting operation.

Press **OK** to confirm the selected item and return to the control panel.

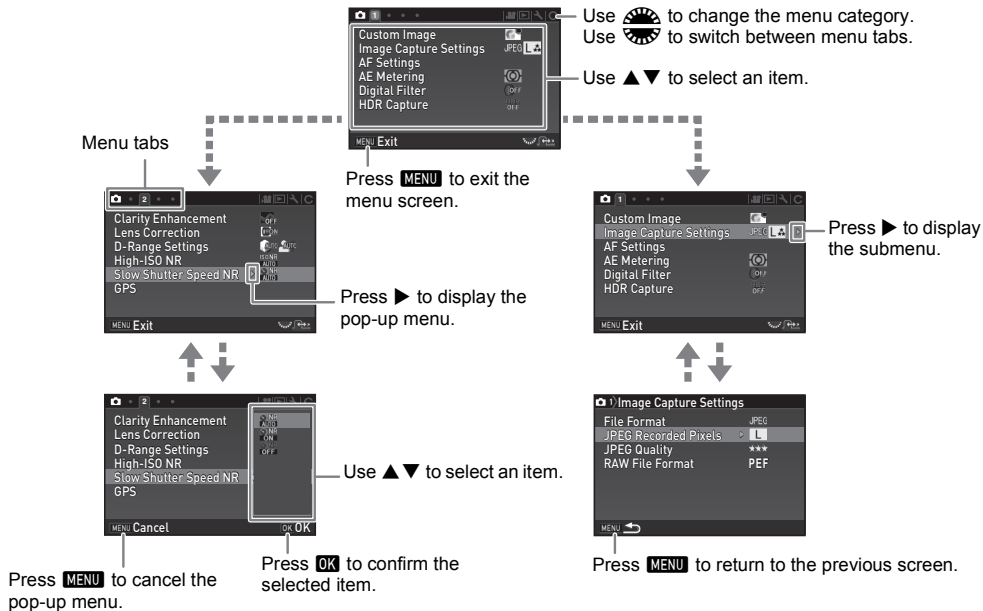
Most functions are set from the menus. The functions that can be set on the control panel can also be set from the menus.





🌀 Memo











- For the Custom Setting menus (C1-5), you can show the setting screen of the next item in order of the menus on the monitor by turning  while the submenu of the currently selected item is displayed.
- Press **MENU** to display the first tab of the proper menus for the camera settings at that time. To display the menu tab last selected first, set in [25 Save Menu Location] of the C4 menu.
- Settings are returned to their default values with [Reset] of the  menu. To reset all the settings in the Custom Setting menus to the defaults, use [Reset Custom Functions] of the C5 menu. (Some settings do not apply.)



Menu List

Rec. Mode Menus

Menu	Item	Function	Default Setting	Page	
	Exposure Mode *1	Temporarily changes the exposure mode when the mode dial is set to U1 or U2 .	P	p.104	
	Custom Image *2 *4	Sets the image finishing tone such as color and contrast before shooting an image.	Bright	p.71	
	Scene Mode *3 *4	Selects the scene mode that best suits the situation. (SCN mode)	Portrait	p.45	
	Image Capture Settings	File Format *4	Sets the file format of images.	JPEG	p.44
		JPEG Recorded Pixels *4	Sets the recording size of JPEG images.	L	
		JPEG Quality *4	Sets the quality of JPEG images.	★★★	
		RAW File Format	Sets the RAW file format.	PEF	
	AF Settings	AF Mode *4	Selects the autofocus method when shooting with the viewfinder.	A.F.A	p.55
		AF Active Area *4	Selects the area to adjust the focus when shooting with the viewfinder.	Auto (11 AF Points)	p.56
		AF Assist Light *4	Discharges the assist light when autofocusing in dark locations.	On	p.55
	AE Metering *4	Selects the part of the sensor to use for measuring brightness and determining exposure.	Multi-segment	p.52	
	Digital Filter *4	Applies a digital filter effect when taking pictures.	No Filter	p.73	
	HDR Capture	HDR Capture *4	Sets the type of high dynamic range shooting.	Off	p.74
		Bracket Value *4	Sets the amount to change the exposure.	±2EV	
Auto Align		Sets whether to automatically adjust the composition.	On		

Menu	Item	Function	Default Setting	Page	
☑2	Clarity Enhancement *4		Enhances the texture and surface details of the subject.	Off	p.76
	Lens Correction	Distortion Correction *4	Reduces distortions occurring due to lens properties.	Off	p.75
		Peripheral Illumin. Corr. *4	Reduces peripheral light fall-off occurring due to lens properties.	Off	
		Lat-Chromatic-Ab Adj	Reduces lateral chromatic aberrations occurring due to lens properties.	On	
		Diffraction Correction	Corrects blur caused by diffraction when using a small aperture.	On	
	D-Range Settings	Highlight Correction *4	Expands the dynamic range and prevents overexposed areas from occurring.	Auto	p.74
		Shadow Correction *4	Expands the dynamic range and prevents underexposed areas from occurring.	Auto	
	High-ISO NR *4		Sets the Noise Reduction setting when shooting with a high ISO sensitivity.	Auto	p.52
	Slow Shutter Speed NR *4		Sets the Noise Reduction setting when shooting with a slow shutter speed.	Auto	p.48
	GPS		Sets the camera action when the optional GPS unit is used.	–	p.117
☑3	Live View	Contrast AF *4	Sets the autofocus mode for shooting with Live View.	Face Detection	p.57
		Focus Peaking *4	Emphasizes the outline of the subject in focus and makes it easier to check the focus.	Off	p.57
		Grid Display	Displays the grid during Live View.	Off	p.11
		Histogram Display	Displays the histogram during Live View.	Off	
		Highlight Alert	Sets overexposed areas to blink red during Live View.	Off	
	Electronic Level	Viewfinder	Displays the electronic level in the EV bar scale in the viewfinder.	Off	p.17
		Live View	Displays the electronic level in Standard Information Display of Live View.	On	p.11
	Horizon Correction		Corrects horizontal tilt when in  mode.	Off	–
	AA Filter Simulator *4		Applies a low-pass filter effect using the Shake Reduction mechanism.	Off	p.76
	Shake Reduction *4		Activates the Shake Reduction function.	On	–
	Input Focal Length		Sets the focal length when using a lens of which focal length information cannot be obtained.	35mm	p.116

Menu	Item	Function	Default Setting	Page	
 4	Instant Review	Display Time	Sets the Instant Review display time.	1sec.	p.40
		Zoom Review	Displays the magnified image during Instant Review.	On	
		Save RAW Data	Saves the RAW data during Instant Review.	On	
		Delete	Deletes the displayed image during Instant Review.	On	
		Histogram Display	Displays the histogram during Instant Review.	Off	
		Highlight Alert	Sets overexposed areas to blink red during Instant Review.	Off	
	E-Dial Programming	P	Sets the  /  /  operation for each exposure mode.	Tv, Av, P	p.100
		Sv		-, ISO, -	
		Tv		Tv, -, -	
		Av		-, Av, -	
		Av		Tv, Av, P LINE	
		M		Tv, Av, P LINE	
		B		-, Av, -	
				-, -, -	
				-, Av, P LINE	
	Tv, Av, P LINE				
	Tv, Av, P LINE				
Rotation Direction	Reverses the effect obtained when  or  is turned.	Rotate Right			

Menu	Item	Function	Default Setting	Page	
	Button Customization	RAW/Fx Button	Sets the function for when RAW/Fx is pressed.	One Push File Format	p.100
		AF/AE-L Button	Sets the function for when AF/AE-L is pressed.	Enable AF1	
		AF/AE-L Button (Movie)	Sets the function for when AF/AE-L is pressed in  mode.	Enable AF1	
		Self-portrait Shutter Button	Sets whether to use the self-portrait shutter button as the shutter release button when taking self-portraits.	On	
	Memory	Determines which settings to save when the power is turned off.	On for settings other than Digital Filter, HDR Capture, Clarity Enhancement, and Shooting Info Display	p.105	
	Save USER Mode	You can save frequently used capture settings to U1 or U2 of the mode dial.	–	p.103	



*1 The function appears only when the mode dial is set to **U1** or **U2**.

*2 The function appears in modes other than **SCN** mode.

*3 The function appears in **SCN** mode.

*4 The function can also be set from the control panel.

Movie Menu

Menu	Item	Function	Default Setting	Page
 1	Movie Capture Settings *1	Sets the number of recorded pixels and the framerate of the movie.	 /30p	p.44
	Recording Sound Level *1	Sets the Recording Sound Level for recording.	Auto	p.50
	Digital Filter *1	Applies a digital filter effect when recording a movie.	No Filter	p.73
	HDR Capture *1	Sets the type of high dynamic range shooting.	Off	p.74
	Clarity Enhancement *1	Enhances the texture and surface details of the subject.	Off	p.76
	Movie SR *1	Activates the Shake Reduction function.	On	–

*1 The function can also be set from the control panel.

Playback Menu





Menu	Item	Function	Default Setting	Page	
 1	Slideshow	Display Duration	Sets an image display interval.	3sec.	p.80
		Screen Effect	Sets a transition effect when the next image is displayed.	Off	
		Repeat Playback	Starts the slideshow again from the beginning after the last image is displayed.	Off	
		Auto Movie Playback	Plays back movies during the slideshow.	On	
	Quick Zoom	Sets the initial magnification when magnifying images.	Off	–	
	Highlight Alert	Sets overexposed areas to blink red in Standard Information Display or Histogram Display in playback mode.	Off	–	
	Auto Image Rotation	Rotates images which were captured with the camera held vertically or of which the rotation information has been changed.	On	p.80	
	Protect All Images	Protects all stored images at once.	–	–	
	Delete All Images	Deletes all stored images at once.	–	–	

Set-up Menus

1

Introduction

Menu	Item	Function	Default Setting	Page	
1	Language/言語	Changes the display language.	English	p.37	
	Date Adjustment	Sets the date and time and the display format.	01/01/2015	p.37	
	World Time	Switches between the date and time display of your hometown city and that of a specified city.	Hometown	p.105	
	Text Size	Magnifies the text size when selecting a menu item.	Std.	p.37	
	Sound Effects	Switches the operation sound on/off and changes the volume for In-focus, AE-L, Self-timer, Remote Control, Change AF Point, One Push File Format, Shake Reduction, and Wi-Fi operations.	Volume 3/ All On	–	
	LCD Display	Guide Display	Displays the operation guides when the capture mode is changed.	On	p.39
		Display Color	Sets the display color of the status screen, control panel and menu cursor.	1	p.38
	LCD Display Settings		Adjusts the brightness, saturation and the color of the monitor.	0	–
2	USB Connection	Sets the USB connection mode when connecting to a computer.	MSC	p.82	
	HDMI Out	Sets the output format when connecting to an AV device with an HDMI input terminal.	Auto	p.81	
	Folder Name	Sets the folder name in which images are stored.	Date	p.106	
	Create New Folder	Creates a new folder on the memory card.	–	p.107	
	File Name	Sets the file name assigned to an image.	IMGP/_IMG	p.108	
	File No.	Sequential Numbering	Continues the sequential numbering for the file name when a new folder is created.	On	p.108
		Reset File Number	Resets the file number setting and returns to 0001 each time a new folder is created.	–	
	Copyright Information		Sets the photographer and copyright information embedded in the Exif data.	Off	p.109

Menu	Item	Function	Default Setting	Page	
3	Flicker Reduction	Cuts down on the screen flicker by setting the power frequency.	50Hz	–	
	Auto Power Off	Sets the time until the camera turns off automatically if no operations are made for a certain period of time.	1min.	p.36	
	Indicator Lamps	Other Indicator Lamps	Lights up the main switch lamp, self-portrait shutter button lamp, and OK lamp when the power is turned on.	High	p.10
		Self-timer	Lights up the remote control receiver lamp during the countdown for Self-timer shooting.	On	
		Remote Control	Lights up the remote control receiver lamp during the standby and countdown for Remote Control shooting and after Remote Control shooting.	On	
	Wi-Fi	Activates the built-in Wi-Fi function.	Off	p.89	
Reset	Resets the settings of the direct keys and for the items of the  menu,  menu,  menu,  menu, control panel, and playback mode palette.	–	–		
4	Pixel Mapping	Maps out and corrects any defective pixels on the sensor.	–	p.119	
	Dust Removal	Cleans the sensor by shaking it.	Off	p.119	
	Sensor Cleaning	Locks the mirror in the up position for cleaning the sensor with a blower.	–	p.120	
	Format	Formats a memory card.	–	p.38	
	Firmware Info/Options	Displays the camera's firmware version. You can check the current firmware version before running an update.	–	–	
	Certification Marks	Displays the certification marks of conformance to wireless technical standards.	–	p.138	

Custom Setting Menus

1

Introduction

Menu	Item	Function	Default Setting	Page
C1	1 EV Steps	Sets the adjustment steps for exposure.	1/3 EV Steps	p.48
	2 Sensitivity Steps	Sets the adjustment steps for ISO sensitivity.	1 EV Step	p.51
	3 Meter Operating Time	Sets the meter operating time.	10sec.	–
	4 AE-L with AF Locked	Sets whether to lock the exposure value when the focus is locked.	Off	–
	5 Link AE and AF Point	Sets whether to link the exposure and AF point in the focusing area.	Off	p.52
	6 Auto EV Compensation	Automatically compensates the exposure when the correct exposure cannot be achieved with the current settings.	Off	–
	7 Bulb (B) Mode Options	Sets the camera operation when pressing SHUTTER in B mode.	Type1	–
C2	8 Bracketing Order	Sets the order for Bracketing shooting.	0 - +	p.62
	9 One-Push Bracketing	Shoots all frames with one release when using Bracketing.	Off	p.62
	10 Interval Shooting Options	Sets whether to start counting the time of interval from when exposure starts or when exposure ends for Interval Shooting, Interval Composite, and Interval Movie Record.	Interval	p.65
	11 AF in Interval Shooting	Sets whether to lock the focus position used when the first picture is taken or perform autofocus for each exposure for Interval Shooting and Interval Composite.	Locks focus at 1st exposure	p.65
	12 WB Adjustable Range	Sets whether to automatically fine-tune the white balance when the light source is specified for the white balance setting.	Fixed	p.69
	13 WB When Using Flash	Sets the white balance setting when using a flash.	Auto White Balance	p.69
	14 AWB in Tungsten Light	Sets the tungsten light color tone when the white balance is set to [Auto White Balance].	Strong Correction	p.69

Menu	Item	Function	Default Setting	Page
C3	15 Color Temperature Steps	Sets the adjustment steps for the Color Temperature option of the white balance.	Kelvin	p.70
	16 Superimpose AF Area	Displays the active AF point in red in the viewfinder.	On	p.16
	17 AF.S Setting	Sets the action priority for when the autofocus mode is set to A.F.S and SHUTTER is fully pressed.	Focus-priority	p.55
	18 1st Frame Action in AF.C	Sets the action priority for the first frame when the autofocus mode is set to A.F.C and SHUTTER is fully pressed.	Release-priority	p.55
	19 Action in AF.C Continuous	Sets the action priority during Continuous Shooting when the autofocus mode is set to A.F.C .	Focus-priority	p.55
	20 Hold AF Status	Maintains the focus for a certain amount of time when the subject happens to move out of the selected focusing area after being focused.	Off	p.55
	21 AF with Remote Control	Sets whether to use autofocus when shooting with a remote control unit.	Off	p.61
C4	22 Release While Charging	Sets whether to release the shutter while the built-in flash is being charged.	Off	p.53
	23 Color Space	Sets the color space to use.	sRGB	–
	24 Save Rotation Info	Saves rotation information when shooting.	On	p.80
	25 Save Menu Location	Saves the last menu tab displayed on the monitor and displays it again the next time MENU is pressed.	Reset Menu Location	p.20
	26 Catch-in Focus	Enables Catch-in Focus shooting when a manual focus lens is attached. The shutter is released automatically when the subject comes into focus.	Off	–
	27 AF Fine Adjustment	Allows you to precisely fine tune your lenses with the camera's autofocus system.	Off	p.58
	28 Using Aperture Ring	Enables the shutter to release when the lens aperture ring is set to a position other than A (Auto).	Disable	p.115
C5	Reset Custom Functions	Resets all the settings of the Custom Setting menus to the defaults.	–	–

Attaching the Strap

- 1 Pass the end of the strap through the strap lug and secure it on the inside of the clasp.

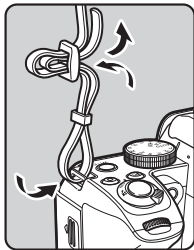

- 2 Attach the other end in the same manner.

Attaching a Lens

- 1 Make sure that the camera is turned off.
- 2 Remove the body mount cover (1) and lens mount cover (2).

After removing the cover, be sure to put the lens down with the lens mount side facing upward.

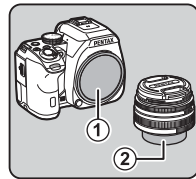

- 3 Align the lens mount indexes (red dots: 3) on the camera and the lens, and secure by turning the lens clockwise until it clicks.

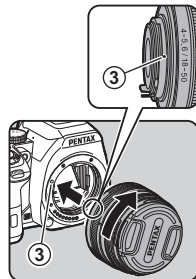

To remove the lens

Attach the lens cap, and then turn the lens counterclockwise while pressing the lens unlock button (4).

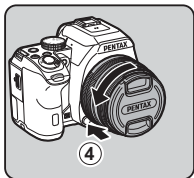

⚠ Caution

- When attaching or removing the lens, choose an environment that is relatively free of dirt and dust.
- Keep the body mount cover attached on the camera when a lens is not attached.
- Be sure to attach the lens mount cover and lens cap to the lens after removing it from the camera.
- Do not insert your fingers inside the lens mount of the camera or touch the mirror.
- The camera body and lens mount incorporate lens information contacts. Dirt, dust, or corrosion may damage the electrical system. Please contact your nearest service center for professional cleaning.
- When a retractable lens is attached and is not extended, you cannot take pictures and use some functions. If the lens is retracted during shooting, the camera stops working. Refer to "How to Use a Retractable Lens" (p.40) for details.
- We assume no responsibility nor liability for accidents, damages and malfunctions resulting from the use of lenses made by other manufacturers.

📄 Memo

- Refer to "Functions Available with Various Lenses" (p.113) for details on the functions of each lens.

Using the Battery and Charger

Use the battery D-LI109 and battery charger D-BC109 exclusively developed for this camera.

Charging the Battery

- 1 Connect the AC plug cord to the battery charger.
- 2 Plug the AC plug cord into the power outlet.

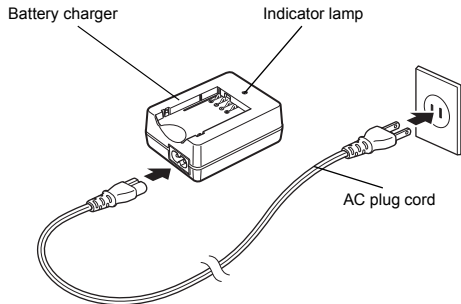

3 Face the ▲ mark on the battery up, and insert it into the battery charger.

Insert the battery into the battery charger at an angle, and then fit into place.

The indicator lamp is lit while charging and turns off when the battery is fully charged.

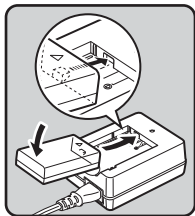

⚠ Caution

- Do not use the battery charger D-BC109 to charge batteries other than the battery D-LI109. Charging other batteries may cause damage or heating.
- Replace the battery with a new one in the following cases:
 - If the indicator lamp blinks or does not light after the battery is inserted correctly
 - If the battery starts to run down more quickly even after being charged (the battery may have reached the end of its service life)

📝 Memo

- The maximum charging time is approximately 240 minutes (it depends on temperature and remaining battery power). Charge in a location where the temperature is between 0°C and 40°C (32°F and 104°F).

Inserting/Removing the Battery

⚠ Caution

- Insert the battery correctly. If the battery is inserted incorrectly, it may not be removed.
- Wipe the electrodes of the battery with a soft dry cloth before inserting.
- Do not open the battery cover or remove the battery while the power is on.
- Be careful as the camera or battery may become hot after the camera has been used continuously for a long period of time.
- Remove the battery when you will not use the camera for a long time. The battery may leak and damage the camera if left installed during prolonged periods of non-use. If the removed battery will not be used for six months or longer, charge the battery for about 30 minutes before storing it. Be sure to recharge the battery every six to twelve months.
- Store the battery in a location where the temperature will remain at or below room temperature. Avoid locations with high temperatures.
- The date and time may be reset if you leave the battery out of the camera for long periods of time. If this happens, set the current date and time again.

1 Open the battery cover.

Slide the battery cover unlock lever (1) before opening the cover.

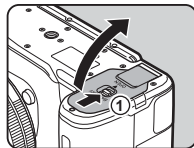

- 2** Face the ▲ mark on the battery towards the outside of the camera, and insert the battery until it locks into place.

To remove the battery, push the battery lock lever in the direction of ②.

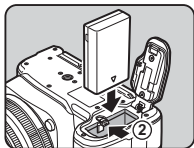

- 3** Close the battery cover.



Memo

- The battery level may not be displayed properly if the camera is used at low temperatures or when performing Continuous Shooting for a long time.
- Battery performance temporarily decreases as the temperature decreases. When using the camera in cold climates, have extra batteries at hand and keep them warm in your pocket. Battery performance will return to normal at room temperature.
- Have extra batteries ready when traveling overseas, or taking a lot of pictures.

Using the AC Adapter

We recommend the use of the optional AC adapter kit K-AC128 when using the monitor for a long time or when connecting the camera to a computer or AV device.

- 1** Make sure that the camera is turned off.
- 2** Open the battery cover.
Remove the battery if it is inserted in the camera.
- 3** Pull out the connection cable cover on the right side of the battery chamber.

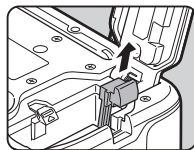

- 4** Insert the DC coupler into the battery chamber.

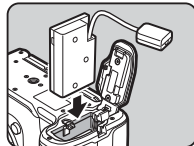

- 5** Close the battery cover.
Make sure that the connection cable comes out from the connection cable opening.

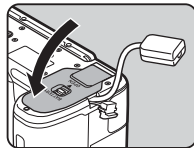

6 Connect the DC coupler and the AC adapter.

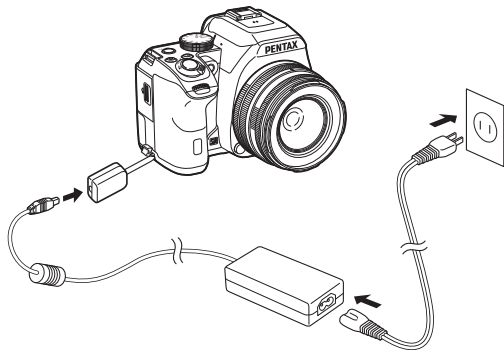

7 Connect the AC adapter to the AC plug cord, and plug the cord into the power outlet.

⚠ Caution

- Make sure that the camera is turned off before connecting or disconnecting the AC adapter.
- Make sure that connections are secure between the terminals. The memory card or data may be corrupted if the connection to the power supply is lost while the card is being accessed.
- After removing the DC coupler, return the connection cable cover to its original position.
- Be sure to read the manual of the AC adapter kit before using the AC adapter.

Inserting a Memory Card

The following memory cards can be used with this camera.

- SD Memory Card
- SDHC Memory Card
- SDXC Memory Card

In this manual, these cards are referred to as memory cards.

1 Make sure that the camera is turned off.

2 Slide the memory card cover in the direction of ① and then rotate it to open as shown by ②.

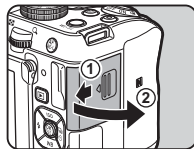

3 Insert the card all the way into the memory card slot with the memory card label facing toward the side with the monitor.

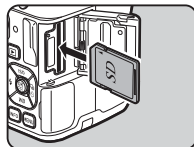

Push the memory card in once and release to remove.

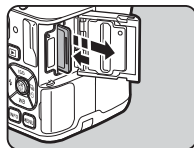

- 4** Rotate the memory card cover as shown by ③, and slide it in the direction of ④.

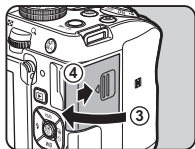

⚠ Caution

- Do not remove the memory card while the card access lamp (orange) is lit.
- If the memory card cover is opened while the power is on, the camera turns off. Do not open the cover while the camera is in use.
- Use this camera to format (initialize) a memory card that is unused or has been previously used on other devices. (p.38)
- Use a high-speed memory card when recording movies. If the write speed cannot keep up with the recording speed, the writing may stop during recording.

How to Open the Monitor

The following procedure explains how to open the monitor with the LCD screen facing inward.

- 1** Open the monitor 180° horizontally while holding the top and bottom of it.

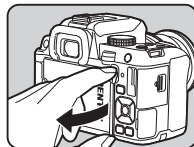

- 2** Rotate the monitor 180° forward.

The monitor can also be rotated up to 90° backward.

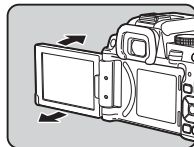

- 3** Close the monitor on the camera so that the LCD screen can be seen.

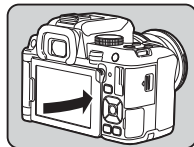

⚠ Caution

- To close the monitor with the LCD screen facing inward, rotate the monitor 180° backward in Step 2.
- When the monitor is closed with the LCD screen facing inward, you cannot play back images and display the menus unless the camera is connected to an AV device equipped with an HDMI terminal.
- Do not hold the camera by the monitor or rotate the monitor beyond its movable range.
- Do not carry the camera or put it in a bag with the monitor open. You can carry the camera when the monitor is closed regardless of the LCD screen direction.

📌 Memo

- The items displayed on the monitor rotate according to the direction and angle of the monitor.
- You can take low-angle and high-angle pictures by adjusting the angle of the monitor while it is open horizontally. Also, you can take self-portraits by pointing the lens toward yourself while checking the Live View image on the LCD screen of the monitor facing you. (p.41)

Initial Settings

Turn the camera on and make the initial settings.

Turning the Camera On**1 Turn the main switch to [ON].**

The lamp lights up in green.
The first time the camera is turned on after purchase, the [Language/言語] screen appears.

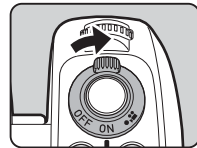
**📌 Memo**

- The power automatically turns off when you do not perform any operations within a set period of time. (Default setting: 1min.) You can change the setting in [Auto Power Off] of the  3 menu. (p.27)

Setting the Display Language

- 1 Use **▲▼◀▶** to select the desired language and press **OK**.

The [Initial Setting] screen appears in the selected language.

Proceed to Step 6 if **🏠** (Hometown) does not need to be changed.

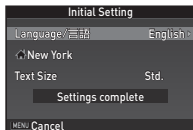

- 2 Press **▼** to move the frame to **🏠** and press **▶**. The [**🏠** Hometown] screen appears.

- 3 Use **◀▶** to select a city. Use **☀️** to change the region. Refer to “List of World Time Cities” (p.128) for cities that can be selected as a hometown.

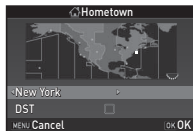

- 4 Press **▼** to select [DST] (daylight saving time), and use **◀▶** to select or .

- 5 Press **OK**.

The camera returns to the [Initial Setting] screen.

- 6 Press **▼** to select [Text Size] and press **▶**.

- 7 Use **▲▼** to select [Std.] or [Large], and press **OK**. Selecting [Large] increases the text size of the selected menu items.

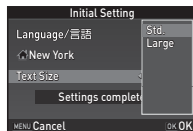

- 8 Press **▼** to select [Settings complete] and press **OK**. The [Date Adjustment] screen appears.

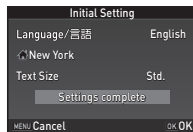

Setting the Date and Time

- 1 Press **▶**, and use **▲▼** to select the date format.

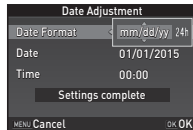

- 2 Press **▶**, and use **▲▼** to select [24h] or [12h].

- 3 Press **OK**.

The frame returns to [Date Format].

- 4 Press **▼**, and then press **▶**.

The frame moves to the month if the date format is set to [mm/dd/yy].

- 5 Use ▲▼ to set the month.**
Set the day, year and time in the same manner.

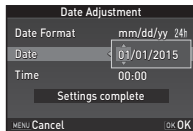

- 6 Press ▼ to select [Settings complete] and press OK.**
The [LCD Display] screen appears.

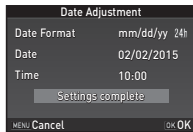

Setting the LCD Display

- 1 Use ◀▶ to select a color.**
Select the display color of the status screen, control panel and menu cursor from colors 1 to 12.

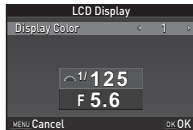

- 2 Press OK.**
The camera switches to capture mode and is ready to take a picture.
- Memo**
- You can change the language, text size, date and time, and LCD display settings from the 1 menu. (p.26)

Formatting a Memory Card



- 1 Press MENU.**
The 1 menu appears.
- 2 Use ☀ or ☾ to display 4 menu.**
- 3 Use ▲▼ to select [Format] and press ▶.**
The [Format] screen appears.
- 4 Press ▲ to select [Format] and press OK.**
Formatting starts. When formatting is completed, the 4 menu reappears.

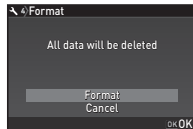

- 5 Press MENU.**
- Caution**
- Do not remove the memory card while formatting, or the card may be damaged.
 - Formatting deletes all data, both protected and unprotected.
- Memo**
- When a memory card is formatted, the volume label "K-S2" is assigned to the card. When the camera is connected to a computer, the memory card is recognized as a removable disk with the name "K-S2".

Basic Shooting Operation

Take pictures using the Auto Picture (**AUTO**) mode in which the camera automatically selects the optimal capture mode.

Shooting with the Viewfinder

- 1 Remove the front lens cap by pushing the top and bottom portions as indicated in the illustration.

When a retractable lens is attached, extend the lens before turning the camera on.

➞ How to Use a Retractable Lens (p.40)

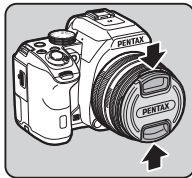

- 2 Turn the camera on.

- 3 Set the focus mode switch to **AF**.

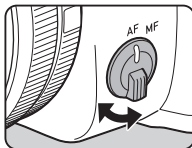

- 4 Turn the mode dial and align the dial indicator to **AUTO**.

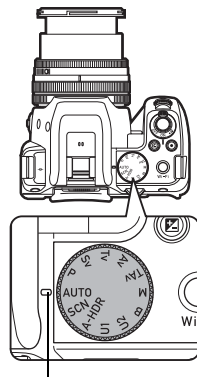

Dial indicator

The selected capture mode is displayed on the monitor (Guide Display).

➞ Guide Display settings (p.26)

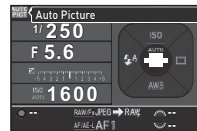

- 5 Look through the viewfinder to view the subject.

When using a zoom lens, turn the zoom ring to the right or left to change the angle of view.

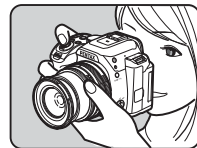

6 Position the subject inside the AF frame and press **SHUTTER** halfway.

The focus indicator (●) appears and you will hear a beep when the subject comes into focus.



Focus indicator

7 Press **SHUTTER** fully.

The captured image is displayed on the monitor (Instant Review).

Available operations during Instant Review



Deletes the image.



Magnifies the image.



Saves the RAW data (only when a JPEG image was taken and the data remains in the buffer).

● Memo

- You can use the **AF/AE-L** button to focus on the subject. (p.54)
- You can select whether to make a beep sound and change the sound volume in [Sound Effects] of the **1** menu. (p.26)
- You can set the operation and display settings for Instant Review in [Instant Review] of the **4** menu. (p.23) When [Display Time] is set to **HOLD**, Instant Review is displayed until the next operation.

How to Use a Retractable Lens

If the camera is turned on when a retractable lens, such as smc PENTAX-DA L 18-50mm F4-5.6 DC WR RE, is attached and is not extended, an error message is displayed on the monitor. Turn the zoom ring in the direction of ② while pressing the button on the ring (①) to extend the lens. When retracting the lens, turn the zoom ring in the opposite direction to ② while pressing the button on the ring and align the white dot to the position ③.

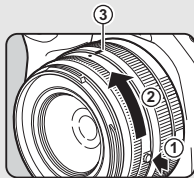



Shooting While Viewing the Live View Image

1 Press **LV** in Step 5 of “Shooting with the Viewfinder” (p.39).

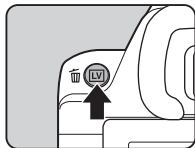
The Live View image is displayed on the monitor.



Available operations

- OK** Magnifies the image.
Use  to change the magnification (up to 10×).
Use  to change the area to display.
Press  to return the display area to the center.
Press **OK** to return to 1× image display.

LV Exits shooting with Live View.

2 Position the subject inside the AF frame on the monitor and press **SHUTTER** halfway.

The AF frame turns green and you will hear a beep when the subject comes into focus.



AF frame

Subsequent steps are the same as shooting with the viewfinder.

Taking a Self-portrait

You can take self-portraits while checking the Live View image by facing the lens and the LCD screen of the monitor toward yourself.

1 In Step 2 of “Shooting While Viewing the Live View Image” (p.41), open the monitor 180° horizontally.

The self-portrait shutter button lamp lights green.

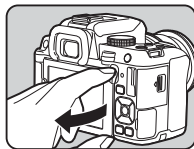

2 Face both the lens and the LCD screen of the monitor toward yourself.

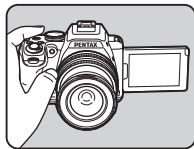

3 Check the Live View image and press the self-portrait shutter button.

After the picture is taken, Instant Review is displayed until the next operation.

The camera returns to standby mode when the self-portrait shutter button is pressed again.

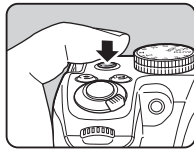

⚠ Caution

- The self-portrait shutter button does not work with a halfway press and needs to be fully pressed down. If the button is pressed when the focus mode is set to **AF**, a picture is taken after autofocus is performed. Even if the subject is not in focus, the shutter release has priority over focusing the subject and a picture is taken.
- When the self-portrait shutter button can be used for shooting, other button/dial operations are disabled.
- You cannot take pictures using the self-portrait shutter button in the following situations.
 - When the camera is connected to an AV device equipped with an HDMI terminal
 - When **SHUTTER** is pressed for the first shutter release in a mode requiring two shutter releases, such as in movie recording mode or in bulb exposure mode. (The same button must be used to start and stop shooting.)
- Images cannot be previewed.
- The image cannot be deleted or magnified during Instant Review.
- Do not force the monitor over the maximum viewing angle.
- Keep the monitor closed when not using the camera.

📄 Memo

- Shooting with the self-portrait shutter button is available only when [Self-portrait Shutter Button] of [Button Customization] in the **4** menu is set to [On] (default setting) and the monitor is positioned at the correct angle. (p.100) When the self-portrait shutter button can be used for shooting, the indicator lamp lights green or red and the main switch lamp turns off. At all other times, the self-portrait shutter button functions as the switch to turn the Wi-Fi function on or off. (p.90)
- Self-portraits can also be taken using a drive mode that employs the self-timer or remote control. (p.59)

Reviewing Images

Review the captured image on the monitor.

1 Press .

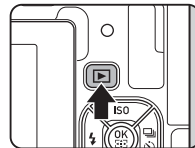















The camera enters playback mode and the most recently captured image is displayed (single image display).



2 Review the captured image.

Available operations

 to the left	Displays the previous image.
 to the right	Displays the next image.
	Deletes the image.
 to the right	Magnifies the image (up to 16×). Use     to change the area to display. Press  to return the display area to the center. Press  to return to the entire image display.
 to the left	Switches to the thumbnail display (p.78).
	Saves the RAW data (only when a JPEG image was taken and the data remains in the buffer).
	Changes the type of information displayed (p.14).
	Displays the playback mode palette (p.77).

Memo

- When  RAW is displayed on the monitor, the JPEG image that was just taken can also be saved in RAW format (Save RAW Data).

Configuring the Capture Settings

Image Capture Settings

Set the file format, recorded pixels, and quality level for still pictures in the control panel or [Image Capture Settings] of the **1** menu.

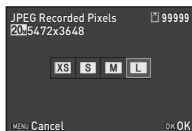
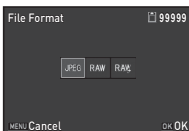

File Format	JPEG, RAW, RAW+
JPEG Recorded Pixels	[L], [M], [S], [XS]
JPEG Quality	★★★, ★★, ★
RAW File Format	PEF, DNG

Memo

- When [File Format] is set to [RAW+], a JPEG image and a RAW image with the same file number are saved at the same time.
- [PEF] of [RAW File Format] is a PENTAX original RAW file format.

Movie Capture Settings



Set the file format for movies in the control panel or [Movie Capture Settings] of the **1** menu.

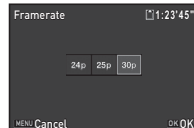

Recorded Pixels	Framerate
[FullHD]	30p, 25p, 24p
[HD]	60p, 50p









Caution

- When the drive mode is set to [Interval Movie Record] or [Star Stream], you cannot set the number of recorded pixels and the framerate. Shooting conditions for Interval Movie Record and Star Stream can be changed from [Parameter Adj.] on the Drive Mode screen.

Taking Still Pictures

Select the capture mode that suits the subject and shooting conditions.

The following capture modes are available on this camera.

Capture Mode	Application	Page
AUTO (Auto Picture modes)	Automatically selects the optimal capture mode from  (Standard),  (Portrait),  (Landscape),  (Macro),  (Moving Object),  (Night Scene Portrait),  (Sunset),  (Blue Sky) or  (Forest).	p.39
SCN (Scene modes)	Offers you various scene modes to choose from.	p.45
A-HDR (Advanced HDR mode)	Takes three consecutive images using the Clarity Enhancement feature to create a single composite image with them.	p.46
P/Sv/Tv/Av/ TAv/M/B (Exposure modes)	Allows you to change the shutter speed, aperture value, and sensitivity.	p.47

⚠ Caution

- The functions that can be set vary depending on the capture mode. Refer to "Restrictions on Each Capture Mode" (p.110) for details.







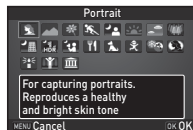

📌 Memo











- You can save frequently used capture modes and settings to **U1** and **U2** so that you can repeatedly use the same modes and settings. (p.103)

Scene Modes

- 1 Set the mode dial to SCN.**
The scene mode selection screen appears.
- 2 Select a scene mode.**



 Portrait	For capturing portraits. Reproduces a healthy and bright skin tone.
 Landscape	For capturing landscape views. Reproduces the vivid green of trees.
 Macro	For capturing tiny objects at close focus range like flowers, coins, jewelry, and more.
 Moving Object	For capturing images of fast moving subjects.
 Night Scene Portrait	For capturing images of people in low light conditions, such as dusk or at night.
 Sunset	For capturing sunrises or sunsets in beautiful, vivid color.
 Blue Sky	For capturing images of blue sky. Produces a more impressive deep blue.
 Forest	Enhances colors of trees and sunbeams through foliage and produces a vivid color image.

 Night Scene	Used for shooting at night.
 Night Scene HDR	Takes three consecutive images at three different exposure levels (-1, ± 0 , +1) to create a single composite image from them.
 Night Snap	For taking snapshots in poorly lit places.
 Food	For capturing images of food. Saturation will be rather high to make food look appetizing.
 Pet	For capturing moving pets.
 Kids	For capturing moving kids. Reproduces healthy and bright skin tone.
 Surf & Snow	For capturing images of dazzling backgrounds, such as snowy mountains.
 Backlight Silhouette	Produces a silhouette image of the subject in backlight conditions.
 Candlelight	For capturing scenes in candlelight.
 Stage Lighting	For capturing moving subjects in poorly lit places.
 Museum	For capturing images in places where a flash is prohibited.

3 Press **OK**.

The camera is in standby mode.

Turn  to change the scene mode.

Memo

- You can change the scene mode also from the control panel or the  1 menu.

Advanced HDR Mode

1 Set the mode dial to **A-HDR**.

2 Turn  to set the range in which to change the exposure.

Select from ± 1 , ± 2 , or ± 3 .



Caution

- This mode cannot be used in combination with some other functions. (p.110)

Exposure Modes

✓: Available #: Restricted ✕: Not available



Mode	Change Shutter Speed	Change Aperture Value	Change Sensitivity	EV Compensation
P Program Automatic Exposure	# *1	# *1	✓	✓
Sv Sensitivity Priority Automatic Exposure	✕	✕	✓ *2	✓
Tv Shutter Priority Automatic Exposure	✓	✕	✓	✓
Av Aperture Priority Automatic Exposure	✕	✓	✓	✓
TAv Shutter & Aperture Priority Automatic Exposure	✓	✓	✓ *3	✓
M Manual Exposure	✓	✓	✓ *2	✓
B Bulb Exposure	✕	✓	✓ *2	✕

*1 You can set the value to be changed in [E-Dial Programming] of the  4 menu. (p.100)

*2 [ISO AUTO] is not available.

*3 Fixed to [ISO AUTO].

1 Set the mode dial to the desired exposure mode.

 or  appears on the status screen for the value that can be changed.



The value that can be changed is underlined in the viewfinder.

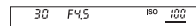

During Live View,  appears for the value that can be changed.



2 Turn .

The aperture value is changed in **Av**, **TAv**, **M**, or **B** mode. The sensitivity is changed in **Sv** mode.

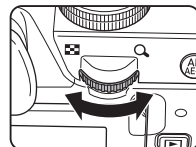

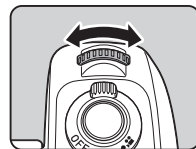

3 Turn .

The shutter speed is changed in **Tv**, **TAv**, or **M** mode.



Memo

- The settings for exposure can be specified in increments of 1/3 EV steps. In [1 EV Steps] of the **C1** menu, you can change the adjustment steps to 1/2 EV steps.
- The correct exposure may not be obtained with the selected shutter speed and aperture value when the sensitivity is set to a certain sensitivity.
- In **M** mode, the difference from the correct exposure is displayed on the EV bar scale while exposure is adjusted.
- In **B** mode, some functions are not available. (p.110)
- For each exposure mode, you can set the camera operation for when  or  is turned or  is pressed. Set in [E-Dial Programming] of the **C4** menu. (p.100)
- When shooting with a low shutter speed, you can reduce image noise from the control panel or [Slow Shutter Speed NR] of the **C2** menu.

Auto	Applies Noise Reduction according to the shutter speed, sensitivity, and internal temperature of the camera.
On	Applies Noise Reduction when the shutter speed is slower than 1 second.
Off	Does not apply Noise Reduction at any shutter speed.

Checking the Depth of Field (Preview)

When [Optical Preview] or [Digital Preview] is assigned to **RAW/Fx** in [RAW/Fx Button] of [Button Customization] in the **C4** menu, you can check the depth of field before taking pictures. (p.100)

EV Compensation

The compensation value can be set between -5 and +5 EV (-2 and +2 EV in  mode).

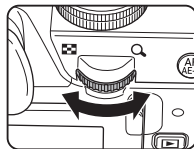
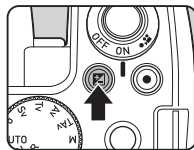

- 1 Press , and then turn .

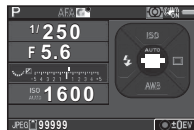

 and the compensation value are displayed on the status screen, Live View screen, and in the viewfinder during adjustment.



Available operations

-  Starts/ends adjusting the compensation value.
-  Resets the adjustment value to the default setting.

Memo

- Bracketing shooting enables you to take pictures while automatically changing exposure. (p.62)

Locking the Exposure

To lock the exposure before shooting, use the AE Lock function. This function can be used by assigning [AE Lock] to the **AF/AE-L** button. (p.100)

Recording Movies

- 1 Turn the main switch to .

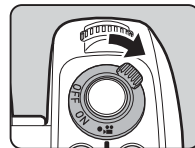

The indicator lamp lights red and the Live View image is displayed.

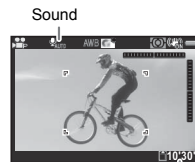

Sound

Recordable Time

- 2 Set the mode dial to the desired capture mode.

The following settings are available depending on the capture mode.

Av/TAv/M	The camera operates in the selected exposure mode. (The aperture value can be changed only before shooting. When set to M mode, the sensitivity can also be changed.)
U1/U2	The camera operates according to the saved exposure mode.
Other modes	The camera operates in P mode.

- 3 Focus on the subject.

In **AF** mode, press **SHUTTER** halfway.

4 Press **SHUTTER fully.**

Movie recording starts.

In the upper left area of the monitor, "REC" blinks and the size of the recorded movie file is displayed.

5 Press **SHUTTER fully again.**

Movie recording stops.

6 Return the main switch to the [ON] position to exit **MF mode.**

The camera returns to shooting with the viewfinder in **AF** mode.

Caution

- When recording a movie with sound, the camera operation sounds are also recorded.
- When recording a movie with an image processing function such as Digital Filter applied, the movie file may be saved with some frames omitted.
- If the internal temperature of the camera becomes high during recording, the recording may be terminated.
- When a retractable lens is attached, recording stops if the lens is retracted during recording and an error message is displayed.
- When the camera enters **MF** mode, the Wi-Fi function is disabled.

Memo

- You can change the settings for recording a movie from the control panel or the **MF** 1 menu. (p.25)
- The sound level for recording a movie can be set from the control panel or [Recording Sound Level] of the **MF** 1 menu. When [Manual] is selected, [Volume] can be set from 0 to 20.
- You can record a movie continuously up to 4 GB or 25 minutes. When the memory card is full, recording stops.

Using a Microphone

You can connect a commercially available stereo microphone to the microphone terminal on the camera. Using an external microphone can also help to reduce the possibility of recording camera operation sounds.

The following specifications are recommended for external microphones.

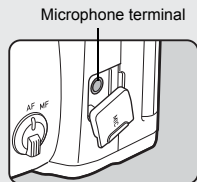

Plug	Stereo mini plug (ø3.5 mm)
Format	Stereo electret condenser
Power	Plug-in Power Method (operating voltage of 2.0 V or lower)
Impedance	2.2 kΩ

Playing Back Movies

- 1 Display the movie to play back in single image display of the playback mode.



Available operations

▲	Plays back/pauses a movie.
▶	Forwards a frame (when paused).
Press and hold ▶	Fast-forwards playback.
◀	Reverses a frame (when paused).
Press and hold ◀	Fast-reverses playback.
▼	Stops playback.
	Adjusts the volume (21 levels).
	Saves the displayed frame as a JPEG file (when paused).
	Switches between [Standard Information Display] and [No Information Display].

Memo

- In [Movie Edit] of the playback mode palette, a movie file can be divided into multiple segments or selected frames can be deleted. (p.86)

Setting the Exposure

Sensitivity

- 1 Press ▲ in standby mode.
- 2 Use ▲▼ to select an item.

ISO AUTO	Sets the range to be adjusted automatically. Both the upper limit and lower limit can be changed.
ISO	Sets a fixed value from ISO 100 to ISO 51200.

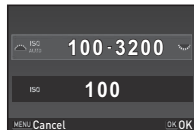

- 3 Use or to change the value.
- 4 Press **OK**.
The camera returns to standby mode.

Memo

- In mode, the sensitivity can be set from ISO 100 to ISO 3200.
- The adjustment steps for ISO sensitivity is 1 EV step. To adjust the sensitivity in accordance with the EV step setting for exposure, set from [2 Sensitivity Steps] of the **C1** menu.

Noise Reduction when Shooting with a High ISO Sensitivity



You can select the desired Noise Reduction setting when shooting with a high ISO sensitivity in the control panel or [High-ISO NR] of the 2 menu.



Auto	Applies Noise Reduction at optimally calculated levels throughout ISO range.
Low/ Medium/ High	Applies Noise Reduction at constant chosen level throughout ISO range.
Custom	Applies Noise Reduction at user-defined levels for each ISO setting.
Off	Does not apply Noise Reduction at any shutter speed.

When [Custom] is selected, the noise reduction level can be set according to the ISO sensitivity value in the 2 menu.

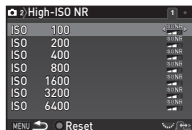

AE Metering



Choose the part of the sensor to use for measuring brightness and determining exposure.

Set in the control panel or [AE Metering] of the 1 menu.

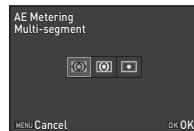

Multi-segment	Meters the brightness in multiple different zones of the sensor. In backlit conditions, this mode automatically adjusts exposure.
Center-weighted	Meters the brightness with an emphasis on the center of the sensor. The sensitivity increases at the center and no automatic adjustment is performed even in backlit conditions.
Spot	Meters the brightness only within a limited area at the center of the sensor. Useful when the subject is small.

Memo

- In [5 Link AE and AF Point] of the **C**1 menu, the metering point and the AF point can be linked.

Using the Built-in Flash

1 Press **◀** in standby mode.

2 Select a flash mode.



	Auto Flash Discharge	Automatically measures the ambient light and determines whether to use the flash.
	Auto Flash + Red-eye Reduction	Discharges a pre-flash for red-eye reduction before an automatic flash.
	Flash On	Discharges a flash for each picture.
	Flash On + Red-eye Reduction	Discharges a pre-flash for red-eye reduction before the main flash and discharges a flash for each picture.
	Slow-speed Sync	Sets to a slow shutter speed and discharges a flash for each picture. Use this, for example, when shooting a portrait with the sunset in the background.
	Slow-speed Sync+Red-eye	Discharges a pre-flash for red-eye reduction before the main flash is discharged with Slow-speed Sync.
	Trailing Curtain Sync	Discharges a flash immediately before closing the shutter. Sets to a slow shutter speed. Captures moving objects as if they are leaving a light trail behind them.
	Manual Flash Discharge	Sets the amount of flash discharge between FULL and 1/128 power.

Available operations

- Compensates the flash exposure. Selects the amount of flash discharge (when [Manual Flash Discharge] is selected).
- Resets the compensation value to the default setting.

3 Press **OK**.

The camera returns to standby mode.

4 Press .

The built-in flash is popped up.

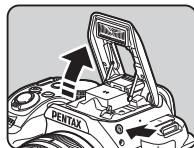

Memo

- The flash modes that can be selected vary depending on the capture mode.

Capture Mode	Selectable Flash Mode
AUTO, SCN*	
P, Sv, Av	
Tv, TvAv, M, B	

The built-in flash cannot be used for some **SCN** modes and for **A-HDR** mode. (p.110)

- You cannot take pictures while the built-in flash is being charged. If you want to take pictures while charging the flash, set [22 Release While Charging] in the **C4** menu.
- Depending on the lens being used, the use of the built-in flash may be limited. (p.114)

- When the built-in flash is used in **Av** mode, the shutter speed automatically changes over a range from 1/180 seconds to a slow shutter speed depending on the lens being used. The shutter speed is locked at 1/180 seconds when a lens other than a DA, DA L, D FA, FA J, FA or F lens is used.
- When the built-in flash is used in **Tv**, **TAv** or **M** mode, any desired shutter speed of 1/180 seconds or slower can be set.
- The built-in flash is optimum for a subject at a distance from approx. 0.7 m to 5 m. Vignetting may occur when used at a distance closer than 0.7 m (this distance varies slightly depending on the lens being used and the sensitivity setting).

Sensitivity	Guide Number	Sensitivity	Guide Number
ISO 100	Approx. 12	ISO 3200	Approx. 68
ISO 200	Approx. 17	ISO 6400	Approx. 96
ISO 400	Approx. 24	ISO 12800	Approx. 136
ISO 800	Approx. 34	ISO 25600	Approx. 192
ISO 1600	Approx. 48	ISO 51200	Approx. 272

- For details on the use of external flashes, refer to “Functions when Using an External Flash” (p.116).

Setting the Focus Method

Set the focus mode switch to **AF** or **MF**.

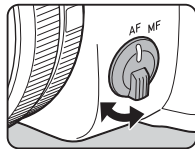

The autofocus method for shooting with the viewfinder differs from that for shooting with Live View.

Shooting with the viewfinder	TTL phase-matching autofocus: Select from A.F.S , A.F.C , or A.F.A mode which enables automatically switching between A.F.S and A.F.C . (p.55) Set the focusing area in [AF Active Area]. (p.56) Faster autofocus performance than the contrast detection AF is possible.
Shooting with Live View	Contrast detection AF: Face Detection and Tracking are available. (p.57)

Memo

- You can use the **AF/AE-L** button to focus on the subject. The **AF/AE-L** button operation can be set in [Button Customization] of the  menu. (p.100)

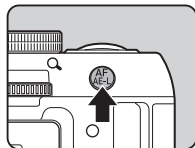

Setting the AF Mode when Shooting with the Viewfinder



- 1 Press **INFO** in standby mode.
- 2 Select **[AF Mode]** and press **OK**.
The [AF Mode] screen appears.
- 3 Select an autofocus mode and press **OK**.

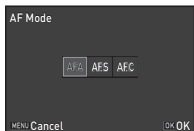

AF.A Auto-select mode	Switches automatically between AF.S and AF.C modes according to the subject.
AF.S Single mode	When SHUTTER is pressed halfway and the subject comes into focus, the focus is locked at that position. The AF assist light turns on as necessary.
AF.C Continuous mode	The subject is kept in focus by continuous adjustment while SHUTTER is pressed halfway. ● appears in the viewfinder when the subject comes into focus. The shutter can be released even if the subject is not in focus.

The control panel reappears.

4 Press **MENU**.

The camera returns to standby mode.

● Memo

- The following settings for autofocus operation can be set in the **C3** menu.

17 AF.S Setting	Focus-priority, Release-priority
18 1st Frame Action in AF.C	Release-priority, Auto, Focus-priority
19 Action in AF.C Continuous	Focus-priority, Auto, FPS-priority
20 Hold AF Status	Off, Low, Medium, High





In [20 Hold AF Status], you can set whether to immediately reactivate autofocus or to maintain the focus for a certain amount of time before reactivating autofocus when the subject happens to move out of the selected focusing area after being focused. The default setting is to immediately reactivate autofocus when the subject moves out of focus.

- In **SCN** mode, [AF Mode] is fixed to **AF.S** or **AF.C** depending on the selected scene mode. (p.110)
- In **AUTO** mode, [AF Mode] is fixed to **AF.A**.

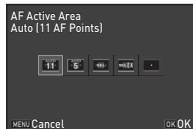
Selecting the Focusing Area (AF Point)

- 1 Press **INFO** in standby mode.
- 2 Select **[AF Active Area]** and press **OK**.
The **[AF Active Area]** screen appears.
- 3 Select the desired focus point selection mode and press **OK**.



 Auto (11 AF Points)	Out of the 11 AF points, the camera automatically selects the optimum focusing area.
 Auto (5 AF Points)	Out of the 5 AF points, the camera automatically selects the optimum focusing area.
 Select	Sets the focusing area to the user selected point from 11 points.
 Expanded Area AF	Sets the focusing area to the user selected point from 11 points. When the subject happens to move out of the selected focusing area after being focused, 8 peripheral points are used as back-up points. Not available in A.F.S mode.
 Spot	Sets the focusing area to the center of the 11 points.

The control panel reappears.

4 Press **MENU**.

The camera returns to standby mode.

If you selected **RAW** or **REC** in Step 3, proceed to Step 5.

5 Select the desired AF point.



Available operations



Changes the AF point.



Returns the AF point to the center.

Press and hold **OK**

Switches the function of the arrow keys () to the Change AF Point mode or the direct key operation.





Memo

- When **RAW** or **REC** is selected, the **OK** lamp lights up.
- The AF point can also be changed from **[AF Active Area]** of **[AF Settings]** in the  menu.
- You can also set the camera so that switching to the Change AF Point mode by pressing and holding **OK** can be operated with **RAW/Fx**. (p.100)



Setting the AF Mode during Live View

- 1 Press **INFO** in standby mode in Live View.
- 2 Select **[Contrast AF]** and press **OK**.
The [Contrast AF] screen appears.
- 3 Select an autofocus mode and press **OK**.



 Face Detection	Detects and tracks faces of people. The main face detection frame for AF and AE is displayed in yellow.
 Tracking	Tracks the subject in focus. The shutter can be released even if the subject is not in focus.
 Multiple AF Points	Sets the focusing area to the desired area. The sensor is divided into 35 areas (7 horizontal by 5 vertical), and you can select a wider or narrower focusing area by using 35, 25, 15, 9, or just 1 of those 35 areas available.
 Select	Sets the focusing area by the pixel.
 Spot	Sets the focusing area to a limited area at the center.

The control panel reappears.



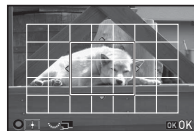

- 4 Press **MENU**.
The camera returns to standby mode.
If you selected  or  in Step 3, proceed to Step 5.

5 Press and hold **OK**.

- 6 Select the AF area.
Use the frame that appears on the monitor to change the position and size of the AF area.



Available operations









-  Changes the position of the AF area.
-  Increases/reduces the size of the AF area (when  is selected).
-  Returns the AF area to the center.

- 7 Press **OK**.
The AF area is set.

⚠ Caution

- When  is selected, the focus lock operation (composition adjustment with the half press of **SHUTTER**) does not work.

📌 Memo

- When  or  is selected, the **OK** lamp lights up.
- The setting can also be changed from [Contrast AF] of [Live View] in the 3 menu.
- The autofocus mode is fixed to  in **AUTO** mode and , , and  of **SCN** mode.
- When [Focus Peaking] is set to [On] in the control panel or [Live View] of the 3 menu, the outline of the subject in focus is emphasized and makes it easier to check the focus. This function works in both **AF** and **MF** modes.

AF Fine Adjustment

C4

You can precisely fine tune your lenses with the camera's autofocus system.

- 1** Select [27 AF Fine Adjustment] in C4 menu and press **▶**.

The [27 AF Fine Adjustment] screen appears.



- 2** Select [Apply All] or [Apply One] and press **OK**.

Apply All	Applies the same adjustment value to all lenses.
Apply One	Saves an adjustment value for the lens being used. (Up to 20 values)

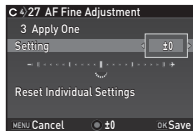
- 3** Select [Setting] and adjust the value.



Available operations

- | | |
|--|---|
|  to the right | Adjusts the focus to a closer position. |
|  to the left | Adjusts the focus to a farther position. |
|  | Resets the adjustment value to the default setting. |

- 4** Press **OK**.

The adjustment value is saved.

- 5** Press **MENU** twice.

The camera returns to standby mode.

Setting the Drive Mode

You can choose from the following drive modes.

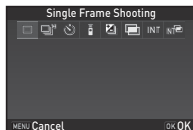

Single Frame Shooting (□)	Normal capture mode
Continuous Shooting (□/□)	Continuously takes pictures while SHUTTER is kept pressed. (p.60)
Self-timer (○/○/○)	Releases the shutter about 12 seconds or 2 seconds after SHUTTER is pressed. (p.60)
Remote Control (⏏/⏏/⏏)	Enables shooting with remote control. (p.61)
Bracketing ([]/[]/[])	Takes three consecutive pictures at different exposure levels. (p.62)
Multi-exposure ([]/[]/[]/[])	Creates a composite image by taking multiple pictures and merging them into a single image. (p.63)
Interval Shooting (INT/INT/INT)	Automatically takes pictures at a set interval from a set time. (p.64)
Interval Composite (INT/INT/INT)	Takes pictures at a set interval from a set time and merges them into a single image. (p.65)
Interval Movie Record (INT/INT/INT)	Takes pictures at a set interval from a set time and saves them as a single movie file. (p.66)

Star Stream



Takes pictures at a set interval from a set time and saves them as a single movie file using the Bright composite mode of Interval Composite. (p.67)

⚠ Caution

- There are restrictions on some drive modes when used in some capture modes or in combination with some other functions. (p.110)

📝 Memo

- In mode, Remote Control (⏏ only), Interval Movie Record, and Star Stream can be selected.
- The Drive Mode setting is saved even after the power is turned off. If [Drive Mode] is set to [Off] in [Memory] of the menu, the setting returns to [Single Frame Shooting] when the power is turned off. (p.105)
- The Shake Reduction function is automatically turned off when the drive mode that employs self-timer or remote control is selected.
- When the drive mode that employs the self-timer or remote control is selected, exposure may be affected by the light entering through the viewfinder. In such a case, use the AE Lock function. (p.49)



Continuous Shooting

- 1 Press ► in standby mode.**
The Drive Mode screen appears.

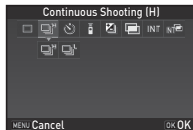
- 2 Select  and press ▼.**



- 3 Use ◀▶ to select  or , and press OK.**

	Continuously takes pictures at high speed.
	Continuously takes pictures at low speed.

The camera returns to standby mode.

Memo

- When [AF Mode] is set to **AF.S**, the focus position is locked in the first frame.



Self-timer

- 1 Press ► in standby mode.**
The Drive Mode screen appears.

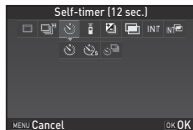
- 2 Select  and press ▼.**



- 3 Use ◀▶ to select , , or .**

	Releases the shutter after about 12 seconds.
	Releases the shutter after about 2 seconds.
	Continuously takes pictures. (The shutter is released after about 12 seconds.)

Proceed to Step 7 when  or  is selected.

- 4 Press **INFO**.**

- 5 Use ◀▶ to set [Shooting Speed] and [Number of Shots].**

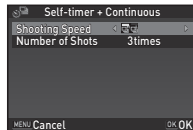

- 6 Press **OK**.**

The screen of Step 2 reappears.

- 7 Press **OK**.**

The camera returns to standby mode.

- 8 Press **SHUTTER** halfway, and then fully.**

The shutter is released after about 12 seconds or 2 seconds.

Remote Control

- 1** Press **▶** in standby mode.
The Drive Mode screen appears.

- 2** Select **⏻** and press **▼**.

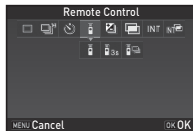

- 3** Use **◀▶** to select **⏻**, **⏻_{3s}**, or **⏻_∞**.

⏻_{3s}	Releases the shutter after about 3 seconds.
⏻_∞	Continuously takes pictures.

Proceed to Step 7 when **⏻** or **⏻_{3s}** is selected.

- 4** Press **INFO**.

- 5** Use **◀▶** to set [Shooting Speed].

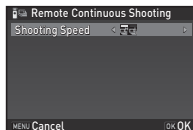

- 6** Press **OK**.
The screen of Step 2 reappears.

- 7** Press **OK**.
The camera returns to standby mode.

- 8** Press **SHUTTER** halfway.

- 9** Point the remote control unit towards the remote control receiver on the front of the camera, and press the shutter release button on the remote control unit.

Memo

- The maximum operating distance of the remote control unit is approx. 4 m from the front of the camera.
- To adjust focus with remote control, set in [21 AF with Remote Control] of the **C3** menu.
- When using the Remote Control Waterproof O-RC1, the autofocus system can be operated with the **1/∞** button on the remote control unit. The **Fn** button cannot be used.



Bracketing

- 1** Press **▶** in standby mode.
The Drive Mode screen appears.

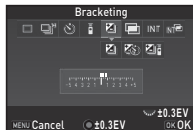
- 2** Select  and press **▼**.



- 3** Use **◀▶** to select , , or .

	Takes pictures with the self-timer.
	Takes pictures with remote control.

Proceed to Step 7 when  is selected.

- 4** Press **INFO**.

- 5** Use **◀▶** to select the operation mode.

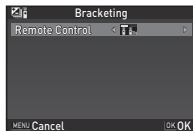
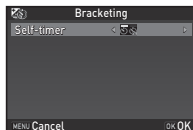

- 6** Press **OK**.
The screen of Step 2 reappears.

- 7** Set the bracket value.

Available operations



Changes the bracket value (up to ± 3 EV).



Adjusts the exposure compensation value.



Resets the compensation value to the default setting.

- 8** Press **OK**.
The camera returns to standby mode.

- 9** Take three pictures.
After three pictures are taken, the camera returns to standby mode in Step 8.

Memo

- The bracket value can be set in increments of 1/3 EV steps or 1/2 EV steps according to the [1 EV Steps] setting of the **C1** menu.
- The following settings for the Bracketing can be set in the **C2** menu.

8 Bracketing Order	Changes the shooting order of the three pictures.
9 One-Push Bracketing	Takes all three pictures with one release of the shutter.



Multi-exposure

- 1 Press **▶** in standby mode.
The Drive Mode screen appears.

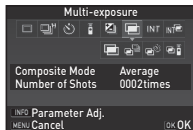
- 2 Select  and press **▼**.



- 3 Use **◀▶** to select , , , or .

	Continuously takes pictures.
	Takes pictures with the self-timer.
	Takes pictures with remote control.

Proceed to Step 7 if you do not need to change the shooting conditions.

- 4 Press **INFO**.

- 5 Set the shooting conditions.

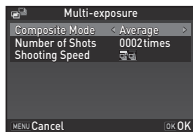



Composite Mode	Select from [Average], [Additive], or [Bright].
Number of Shots	Select from 2 to 2000 times.
Shooting Speed/ Self-timer/ Remote Control	Select the operation mode.

- 6 Press **OK**.
The screen of Step 2 reappears.

- 7 Press **OK**.
The camera returns to standby mode.

- 8 **Shoot**.
Instant Review is displayed.

Available operations during Instant Review

	Discards pictures taken up to that point and takes pictures again from the first picture.
MENU	Saves pictures taken up to that point and displays the  menu.

After the specified number of shots are taken, the camera returns to standby mode in Step 7.

Memo

- Composite images are created as follows in each Composite Mode.

Average	Creates a composite image with the average exposure.
Additive	Creates a composite image with the cumulatively added exposure.
Bright	Creates a composite image replacing only the portions that are brighter compared with the first image.

Interval Shooting

- 1** Press **▶** in standby mode.
The Drive Mode screen appears.

- 2** Select **INT** and press **▼**.

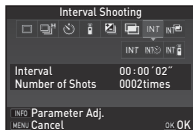

- 3** Use **◀▶** to select **INT**, **INT**, or **INT**.

INT	Takes pictures with the self-timer.
INT	Takes pictures with remote control.

Proceed to Step 7 if you do not need to change the shooting conditions.

- 4** Press **INFO**.

- 5** Set the shooting conditions.

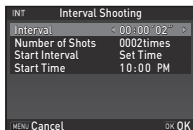

Interval	Select from 2 seconds to 24 hours.
Standby Interval	Select from the minimum time or 1 second to 24 hours.
Number of Shots	Select from 2 to 2000 times.
Start Interval	Select whether to take the first picture now or at a set time.
Start Time	Set the shooting start time when [Start Interval] is set to [Set Time].
Self-timer/ Remote Control	Select the operation mode.

- 6** Press **OK**.
The screen of Step 2 reappears.

- 7** Press **OK**.
The camera returns to standby mode.

- 8** Shoot.
When [Start Interval] is set to [Now], the first picture is taken. When set to [Set Time], shooting starts at the set time.

To cancel shooting, press **MENU** in standby mode.
After the specified number of shots are taken, the camera returns to standby mode in Step 7.

Memo

- A new folder is created when Interval Shooting is performed, and the captured images are saved there. When shooting in another drive mode after performing Interval Shooting, another new folder is created.
- The shortest time that can be set for [Interval] is 5 seconds for [Digital Filter] and [Clarity Enhancement], and 10 seconds for [HDR Capture] and **A-HDR** mode.
- For Interval Shooting, Interval Composite, and Interval Movie Record, the second and later exposures start at the interval set in [Interval]. If the exposure time is longer than the time set in [Interval], some of the pictures that are supposed to be taken at the set interval are not actually taken. For example, if the time set in [Interval] is 2 seconds and the exposure time is 3 seconds, the first exposure has not yet finished at the time the second exposure is supposed to be started (2 seconds after shooting has started), and so the second picture is not taken. As a result, Interval Shooting ends before the specified number of shots are taken. In such cases, you can set [Standby Interval] in [10 Interval Shooting Options] of the **C2** menu so that pictures are taken at the set interval after each exposure ends. The screen displayed in Step 5 varies depending on the [10 Interval Shooting Options] setting.
- For Interval Shooting and Interval Composite, the focus position used when the first picture is taken is locked. When performing autofocus for each exposure, set [11 AF in Interval Shooting] to [Adjusts focus for each shot] in the **C2** menu.

Interval Composite



Star and moon trails can be captured in one image.

1 Press  in standby mode.
The Drive Mode screen appears.

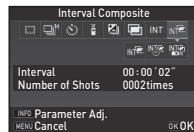
2 Select  and press .



3 Use   to select , , or .

	Takes pictures with the self-timer.
	Takes pictures with remote control.

Proceed to Step 7 if you do not need to change the shooting conditions.

4 Press .

5 Set the shooting conditions.

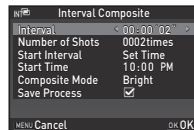

Interval	Select from 2 seconds to 24 hours.
Standby Interval	Select from the minimum time or 1 second to 24 hours.
Number of Shots	Select from 2 to 2000 times.
Start Interval	Select whether to take the first picture now or at a set time.
Start Time	Set the shooting start time when [Start Interval] is set to [Set Time].
Composite Mode	Select from [Average], [Additive], or [Bright].
Save Process	Select <input checked="" type="checkbox"/> to save images in the middle of processing.
Self-timer/ Remote Control	Select the operation mode.

6 Press **OK**.

The screen of Step 2 reappears.

7 Press **OK**.

The camera returns to standby mode.

8 Shoot.

When [Start Interval] is set to [Now], the first picture is taken.

When set to [Set Time], shooting starts at the set time.

To cancel shooting, press **MENU** in standby mode.

After the specified number of shots are taken, the camera returns to standby mode in Step 7.

Memo

- When [Save Process] is set to , a new folder is created and the composite image is saved there. When shooting in another drive mode after performing Interval Composite, another new folder is created.
- Mount the camera on a tripod during shooting.

Interval Movie Record

In  mode, you can use [Interval Movie Record] to take still pictures at a set interval from a set time and save them as a single movie file (Motion JPEG, file extension: .AVI).

- Turn the main switch to  and press **▶**.
The Drive Mode screen appears.

- Select **INT** and press **▼**.

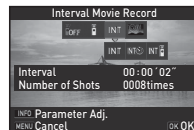

- Use **◀▶** to select **INT**, **INT** with a self-timer icon, or **INT** with a remote control icon.

INT with a self-timer icon	Records a movie with the self-timer.
INT with a remote control icon	Records a movie with remote control.

Proceed to Step 7 if you do not need to change the shooting conditions.

- Press **INFO**.

- Set the shooting conditions.

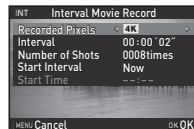

Recorded Pixels	Select from [4K] , [FullHD] , or [HD] .
Interval	Select from 2 seconds to 24 hours.
Standby Interval	Select from the minimum time or 1 second to 24 hours.
Number of Shots	Select from 8 to 2000 times. (When [Recorded Pixels] is set to [4K] , select from 8 to 500 times.)
Start Interval	Select whether to take the first picture now or at a set time.
Start Time	Set the shooting start time when [Start Interval] is set to [Set Time].
Self-timer/ Remote Control	Select the operation mode.

6 Press **OK**.

The screen of Step 2 reappears.

7 Press **OK**.

The camera returns to standby mode.

8 Shoot.

When [Start Interval] is set to [Now], the first picture is taken. Instant Review is displayed, and then the monitor turns off.

To cancel shooting, press **MENU** in standby mode.

After the specified number of shots are taken, the camera returns to standby mode in Step 7.

⚠ Caution

- [Movie SR] is fixed to [Off].
- [Recording Sound Level] is fixed to [Mute].

📝 Memo

- The shortest time that can be set for [Interval] is 5 seconds for [Digital Filter] and [Clarity Enhancement], and 10 seconds for [HDR Capture].

Star Stream

In **📷** mode, you can use [Star Stream] to take still pictures at a set interval from a set time and save them as a single movie file (Motion JPEG, file extension: .AVI) using the Bright composite mode of Interval Composite.

Star and moon trails can be captured as a movie file.

1 Turn the main switch to **📷** and press **▶**.
The Drive Mode screen appears.

2 Select **📷** and press **▼**.

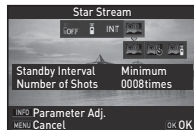

3 Use **◀▶** to select **📷**, **📷**, or **📷**.

📷	Records a movie with the self-timer.
📷	Records a movie with remote control.

Proceed to Step 7 if you do not need to change the shooting conditions.

4 Press **INFO**.

5 Set the shooting conditions.

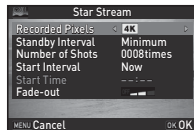

Recorded Pixels	Select from 4K , FullHD , or HD .
Standby Interval	Select from the minimum time or 1 second to 24 hours.
Number of Shots	Select from 8 to 2000 times. (When [Recorded Pixels] is set to 4K , select from 8 to 500 times.)
Start Interval	Select whether to take the first picture now or at a set time.
Start Time	Set the shooting start time when [Start Interval] is set to [Set Time].
Fade-out	Select the fade-out effect level of light trails from Off, Low, Medium, or High.
Self-timer/ Remote Control	Select the operation mode.

6 Press **OK**.

The screen of Step 2 reappears.

7 Press **OK**.

The camera returns to standby mode.

8 Shoot.

When [Start Interval] is set to [Now], the first picture is taken.

When set to [Set Time], shooting starts at the set time.

To cancel shooting, press **MENU** in standby mode.

After the specified number of shots are taken, the camera returns to standby mode in Step 7.

⚠ Caution

- [Movie SR] is fixed to [Off].
- [Recording Sound Level] is fixed to [Mute].

📝 Memo

- The camera operates in **M** mode regardless of the mode dial setting.
- Mount the camera on a tripod during shooting.

Setting the White Balance

1 Press **▼** in standby mode.

The White Balance setting screen appears.

2 Select the desired white balance setting.



AWB	Auto White Balance
	Multi Auto White Balance
	Daylight
	Shade
	Cloudy
	Fluorescent - Daylight Color
	Fluorescent - Daylight White
	Fluorescent - Cool White
	Fluorescent - Warm White
	Tungsten
	Flash
CTE	Color Temperature Enhancement
	Manual White Balance
K	Color Temperature

Available operations when shooting with the viewfinder



Selects the type of [Fluorescent].



Uses Digital Preview to preview the background image with the white balance setting applied.



Saves the preview image (only when the image can be saved).

Proceed to Step 5 if you do not need to fine-tune the white balance.

3 Press **INFO**.

The fine-tuning screen appears.

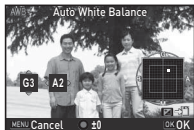

Available operations



Adjust: Green-Magenta



Adjust: Blue-Amber



Resets the adjustment value to the default setting.

4 Press **OK**.

The screen of Step 2 reappears.

5 Press **OK**.

The camera returns to standby mode.

⚠ Caution

- The Digital Preview operation in Step 2 cannot be performed when the drive mode is set to [Multi-exposure], [Interval Shooting], or [Interval Composite].

📝 Memo

- When **A** is set, even if various light sources are present at the shooting location, the camera automatically adjusts the white balance according to the light source of each area. (**A** is not available in **+** mode.)
- The following settings for the white balance can be set in the **C2-3** menus.

12 WB Adjustable Range	Fixed, Auto Adjustment
13 WB When Using Flash	Auto White Balance, Multi Auto White Balance, Flash, Unchanged
14 AWB in Tungsten Light	Strong Correction, Subtle Correction
15 Color Temperature Steps	Kelvin, Mired

Adjusting the White Balance Manually

You can measure the white balance at a selected location.

- 1 Select  in Step 2 of “Setting the White Balance” (p.68).

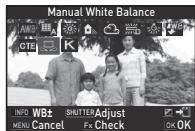

- 2 Under the light you wish to measure the white balance of, select a white area as the subject, and press **SHUTTER** fully.

The captured image is displayed.

- 3 Use **▲▼◀▶** to specify the measuring area.

Press **○** to return the measuring area to the center.



- 4 Press **OK**.

The White Balance setting screen reappears.

[The operation could not be completed correctly] appears when measuring is unsuccessful. Press **OK** to remeasure the white balance and return to Step 3.

Memo

- You can copy the white balance settings of a captured image and save them as manual white balance settings in [Save as Manual WB] of the playback mode palette. (p.77)

Adjusting the White Balance with Color Temperature

Specify the white balance with the color temperature.

- 1 Select **K** in Step 2 of “Setting the White Balance” (p.68).

- 2 Press **INFO**.

- 3 Adjust the color temperature.

Set the color temperature value within the range from 2500K to 10000K.

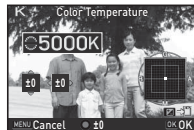

Available operations



Changes the color temperature in increments of 100 Kelvin.



Changes the color temperature in increments of 1000 Kelvin.





Fine-tunes the color temperature.

- 4 Press **OK**.

The White Balance setting screen reappears.

Memo

- Select [Mired] in [15 Color Temperature Steps] of the **C3** menu to set the color temperature in mired units. The color temperature can be changed in 20 mired units with , and 100 mired units with . However, figures are converted to and displayed in Kelvin.

Controlling the Image Finishing Tone

When you want to take pictures with a slightly different style, you can set the desired picture style before shooting. Try out the various settings, and find your best picture style.

Custom Image



- 1 Select [Custom Image] in the control panel, and press **OK**.

The Custom Image setting screen appears.

- 2 Select an image finishing tone.

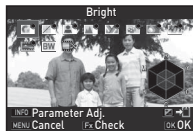

Bright	Muted
Natural	Bleach Bypass
Portrait	Reversal Film
Landscape	Monochrome
Vibrant	Cross Processing
Radiant	

Available operations when shooting with the viewfinder

-
- RAW/FX** Uses Digital Preview to preview the background image with the selected setting applied.
-
- ✓** Saves the preview image (only when the image can be saved).
-

Proceed to Step 6 if you do not need to change the parameters.

- 3 Press **INFO**.
The parameter setting screen appears.

- 4 Set the parameters.

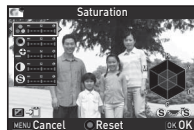

Available operations

-
- ▲▼** Selects a parameter.
-
- ◀▶** Adjusts the value.
-
- ☀** Switches between [Sharpness] and [Fine Sharpness]. (Not available in **📷** mode)
-
- Resets the adjustment value to the default setting.
-

- 5 Press **OK**.
The screen of Step 2 reappears.

6 Press **OK.**

The control panel reappears.

7 Press **MENU.**

The camera returns to standby mode.

⚠ Caution

- This function is not available when in **AUTO** or **SCN** mode.
- The Digital Preview operation in Step 2 cannot be performed when the drive mode is set to [Multi-exposure], [Interval Shooting], or [Interval Composite].

Saving the Cross Processing Settings of a Captured Image

The outcome of Cross Processing varies each time a picture is taken. If you take a cross processed image that you like, you can save the Cross Processing settings used in the image so that you can repeatedly use the same settings.

1 Press **▼ in single image display of playback mode.**

The playback mode palette appears.

2 Select **☰ and press **OK**.**

The camera searches for cross processed images starting from the most recent image taken.

[No cross processed image] appears if there are no cross processed images.

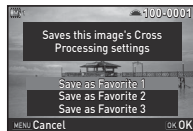
3 Use **☰ to select a cross processed image.****4 Select the "Favorite" number 1, 2 or 3 to save the settings, and press **OK**.**

The settings of the selected image are saved as your "Favorite" settings.

📌 Memo

- The saved Cross Processing settings can be loaded by selecting [Cross Processing] in Step 2 of "Custom Image" (p.71), and selecting one of the Favorite settings 1 to 3 for the parameter.

- 1** Select **[Digital Filter]** in the control panel, and press **OK**.

The Digital Filter setting screen appears.

- 2** Select a filter.

Select **[No Filter]** to not shoot with a digital filter.



Extract Color	Shading
Replace Color	Invert Color
Toy Camera	Unicolor Bold
Retro	Bold Monochrome
High Contrast	

Available operations when shooting with the viewfinder

- RAW/FX** Uses Digital Preview to preview the background image with the selected effect applied.

- Saves the preview image (only when the image can be saved).

Proceed to Step 6 if you do not need to change the parameters.

- 3** Press **INFO**.

The parameter setting screen appears.

- 4** Set the parameters.



Available operations

- ▲▼** Selects a parameter.

- ◀▶** Adjusts the value.

- 5** Press **OK**.

The screen of Step 2 reappears.

- 6** Press **OK**.

The control panel reappears.

- 7** Press **MENU**.

The camera returns to standby mode.

Caution

- This function cannot be used in some capture modes or in combination with some other functions. (p.110)
- The Digital Preview operation in Step 2 cannot be performed when the drive mode is set to **[Multi-exposure]**, **[Interval Shooting]**, or **[Interval Composite]**.
- Depending on the filter used, it may take longer to save images.

Memo

- Images can also be processed with digital filters in playback mode. (p.84)

Correcting Images

Brightness Adjustment

Highlight Correction/Shadow Correction

Expands the dynamic range and enables a wider range of tones to be recorded by the CMOS sensor and reduces the occurrence of overexposed/underexposed areas.

Set in the control panel or [D-Range Settings] of the 2 menu.

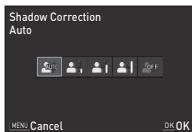
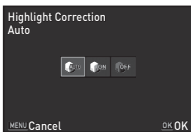

⚠ Caution

- When the sensitivity is set to less than ISO 200, [Highlight Correction] cannot be set to [On].

📌 Memo

- [Highlight Correction] in  mode can be set to [Auto] or [Off].

HDR Capture



Takes three consecutive images at three different exposure levels to create a single composite image with them.

- 1 Select [HDR Capture] in the control panel, and press **OK**.

The [HDR Capture] screen appears.

- 2 Use **◀▶** to select the type.

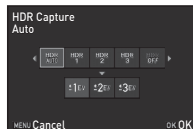

- 3 Press **▼**, and use **◀▶** to set the range in which to change the exposure.

- 4 Press **OK**.

The control panel reappears.



- 5 Press **MENU**.

The camera returns to standby mode.

⚠ Caution

- This function cannot be used in some capture modes or in combination with some other functions. (p.110)
- [File Format] is fixed to [JPEG]. When [File Format] is set to [RAW] or [RAW+], the setting is changed to [JPEG].
- For HDR Capture, multiple images are combined together to create a single image, so it may take time to save the image.
- In  mode, this function is available only when the drive mode is set to [Interval Movie Record].

Memo

- In **A-HDR** mode or when  of **SCN** mode is selected, specific HDR settings are used and HDR Capture cannot be set.
- The Auto Align feature can be set if you access [HDR Capture] from the  1 menu.
- When the drive mode is set to [Interval Shooting], [Auto Align] is fixed to [Off].

Lens Correction



The following features can be set in [Lens Correction] of the  2 menu.

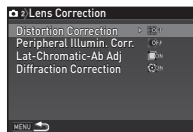

Distortion Correction	Reduces distortions occurring due to lens properties.
Peripheral Illumin. Corr.	Reduces peripheral light fall-off occurring due to lens properties.
Lat-Chromatic-Ab Adj	Reduces lateral chromatic aberrations occurring due to lens properties.
Diffraction Correction	Corrects blur caused by diffraction when using a small aperture.

Memo

- You can also set [Distortion Correction] and [Peripheral Illumin. Corr.] from the control panel.
- Corrections can only be made when a compatible lens is attached. (p.113) The features are disabled when using an accessory such as a rear converter that is attached between the camera and the lens.
- When [File Format] is set to [RAW] or [RAW+], correction information is saved as a RAW file parameter and you can select whether to apply the correction to the images when developing them. For the RAW Development function, [Color Fringe Correction] can also be set. (p.87)

Anti-Aliasing Filter Simulator



By shaking the Shake Reduction unit, a moiré reduction effect simulating that of a low-pass filter can be achieved.

Set in the control panel or [AA Filter Simulator] of the 3 menu.

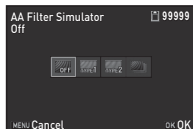

Type1	Takes pictures balancing the resolution and moiré reduction.
Type2	Prioritizes moiré reduction.
Bracketing	Takes consecutive 3 images in order of [Off], [Type1], and [Type2] (3 images are taken with one press of SHUTTER).

⚠ Caution

- This function cannot be used in some capture modes or in combination with some other functions. (p.110)
- [Bracketing] cannot be used in the following situations.
 - When , , or of **SCN** mode is selected
 - In **B** mode
 - When the drive mode is set to other than [Single Frame Shooting], [Self-timer] (12 seconds, 2 seconds), or [Remote Control] (now, after 3 seconds)
 - When HDR Capture is set
 - When the number of storable images is 2 or less

Texture Enhancement



Images with the texture and surface details enhanced can be captured.

Set in the control panel or [Clarity Enhancement] of the 2/1 menu.

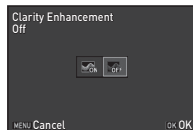

⚠ Caution







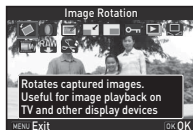

- This function cannot be used in combination with some other functions. (p.112)
- In mode, this function is available only when the drive mode is set to [Interval Movie Record].



Playback Mode Palette Items

Playback functions can be set from the playback mode palette as well as the 1 menu (p.25).

Press  in single image display of the playback mode to display the playback mode palette.



Item	Function	Page
 Image Rotation *1	Changes the rotation information of images.	p.80
 Digital Filter *1	Processes images with digital filters.	p.84
 Color Moiré Correction *1 *2	Reduces color moiré in images.	p.84
 Resize *1 *2	Changes the number of recorded pixels of the image.	p.83
 Cropping *1	Crops out only the desired area of an image.	p.83
 Protect	Protects images from being accidentally erased.	p.106
 Slideshow	Plays back images one after another.	p.80
 Save as Manual WB *1	Saves the white balance settings of the captured image as Manual White Balance.	p.70

Item	Function	Page
 Save Cross Processing	Saves the settings used for an image captured in Cross Processing mode of Custom Image as your "Favorite" settings.	p.72
 RAW Development *3	Develops RAW images into JPEG images and saves them as new files.	p.87
 Movie Edit *4	Divides a movie or deletes unwanted segments.	p.86

*1 Not available when a movie is displayed.

*2 Not available when a RAW image is displayed.

*3 Available only when a RAW image is saved.

*4 Available only when a movie is displayed.

Changing the Playback Method

Displaying Multiple Images

You can display 6, 12, 20, 35 or 80 thumbnail images at the same time.

- 1 Turn  to the left in playback mode.

The multi-image display screen appears.

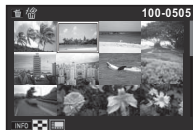



Available operations

 Moves the selection frame.

 Shows the next/previous page.

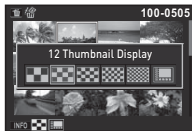
 Shows the display style selection screen.



 Deletes the selected images.

- 2 Press **OK**.

The selected image appears in single image display.

Deleting Selected Images

- 1 Press  in Step 1 of “Displaying Multiple Images” (p.78).
- 2 Select the images to delete.





Available operations

 Moves the selection frame.

 Confirms/cancels the selection of the image to delete.

 Selects the range of images to delete.

 Shows the selected image in single image display.
Use  to select a different image.

In the upper left area of the monitor, the number of selected images is displayed.

- 3 Press .
- The delete confirmation screen appears.

- 4 Select **[Delete]** and press **OK**.

Memo

- You can select up to 500 images at a time.
- Protected images cannot be selected.
- You can delete the images selected individually along with the images selected by specifying the range to delete.

- Use the same steps to select multiple images for the following functions.
 - RAW Development (p.87)
 - Protect (p.106)



Displaying Images by Folder

- 1 Turn  to the left in Step 1 of “Displaying Multiple Images” (p.78).

The folder display screen appears.



Available operations

-   Moves the selection frame.
-  Deletes the selected folder.

- 2 Press **OK**.

The images in the selected folder are displayed.

Deleting a Folder

- 1 Select the folder to delete in Step 1 of “Displaying Images by Folder” (p.79), and press .

The delete confirmation screen appears.

- 2 Select [Delete] and press **OK**.

The selected folder and all the images in it are deleted. When there are protected images in the folder, select [Delete all] or [Leave all].

Displaying Images by Shooting Date

Images are grouped and displayed by shooting date.

- 1 Press **INFO** in Step 1 of “Displaying Multiple Images” (p.78).







The display style selection screen appears.

- 2 Select [Calendar Filmstrip Display].



Shooting date Thumbnail

Available operations

-   Selects a shooting date.
-   Selects an image taken on the selected shooting date.
-   Shows the selected image in single image display.
-  Deletes the selected image.

- 3 Press **OK**.

The selected image appears in single image display.



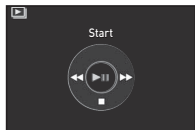

Playing Back Images Continuously (Slideshow)

1 Select in the playback mode palette.

Slideshow starts.



Available operations

	Pauses/resumes playback.
	Displays the previous image.
	Displays the next image.
	Stops playback.
	Adjusts the volume of the movie.

After all images are played back, the camera returns to single image display.

Memo

- You can change the [Display Duration], [Screen Effect], [Repeat Playback], and [Auto Movie Playback] settings for slideshow in [Slideshow] of the 1 menu. Slideshow can also be started from the Slideshow setting screen.

Displaying Rotated Images

When you take pictures with the camera held vertically, image rotation information is saved when shooting. When [Auto Image Rotation] in the 1 menu is set to [On], the image is automatically rotated based on the rotation information during playback (default setting).

The rotation information of an image can be changed by following the procedure below.

1 Display the image to edit in single image display.

2 Select in the playback mode palette.

The selected image is rotated in 90° increments and the four thumbnail images are displayed.

3 Use to select the desired rotation direction and press .

The image rotation information is saved.



Caution

- When [24 Save Rotation Info] is set to [Off] in the **C4** menu, image rotation information is not saved when shooting.
- You cannot change the rotation information in the following cases.
 - Protected images
 - Images without a rotation information tag
- Movie files cannot be rotated.

Connecting the Camera to an AV Device

Connect to an AV device, such as a TV, equipped with an HDMI terminal to display Live View images while shooting or to play back images in playback mode.

Make sure to have a commercially available HDMI cable equipped with an HDMI terminal (type D).

- 1 Turn the AV device and camera off.**
- 2 Open the terminal cover of the camera, and connect the cable to the HDMI terminal.**

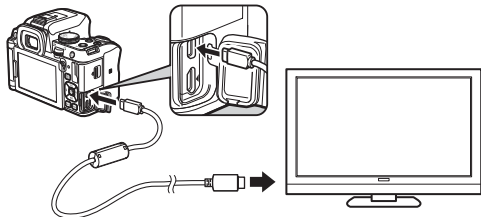

- 3 Connect the other end of the cable to the input terminal on the AV device.**
- 4 Turn the AV device and camera on.**

The camera turns on in HDMI mode, and the camera information is displayed on the screen of the connected AV device.

⚠ Caution

- While the camera is connected to an AV device, nothing is displayed on the camera monitor regardless of the LCD screen direction. Also, you cannot adjust the volume on the camera. Adjust the volume on the AV device.

📌 Memo

- Check the operating manual of the AV device and select a suitable input terminal for connecting the camera.
- By default, the maximum resolution supported by both the AV device and camera is automatically selected. If it fails to play back images properly, change the setting in [HDMI Out] of the  2 menu.
- If you intend to use the camera continuously for a long period, the use of the optional AC adapter kit is recommended.

Connecting the Camera to a Computer

Connect the camera to a computer using a USB cable. Make sure to have a commercially available USB cable equipped with a micro B terminal.

- 1 Turn the computer on.
- 2 Turn the camera off.
- 3 Open the terminal cover of the camera, and connect the USB cable to the USB terminal.

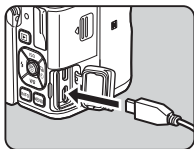

- 4 Connect the USB cable to the USB port of the computer.
- 5 Turn the camera on.
The camera is recognized as a removable disk.
The **OK** lamp of the camera blinks slowly.
- 6 Save the captured images to the computer.
- 7 Disconnect the camera from the computer.

⚠ Caution

- The camera cannot be operated while it is connected to a computer. To operate the camera, terminate the USB connection on the computer, then turn off the camera and remove the USB cable.
- If the "K-S2" dialog appears on the computer screen in Step 5, select [Open folder to view files] and click the OK button.

📄 Memo

- Refer to "Operating Environment for USB Connection and Provided Software" (p.129) for system requirements to connect the camera to a computer and to use the software.
- The USB connection mode when connecting the camera to a computer can be set in [USB Connection] of the **2** menu. Normally, you do not need to change the default setting ([MSC]).
- If you intend to use the camera continuously for a long period, the use of the optional AC adapter kit is recommended.

Editing and Processing Images

Changing the Image Size

Caution

- Only JPEG images captured with this camera can be resized or cropped.
- Images already resized or cropped to the minimum file size cannot be processed.

Changing the Number of Recorded Pixels (Resize)

Changes the number of recorded pixels of the selected image, and saves it as a new file.

1 Display the image to edit in single image display.

2 Select in the playback mode palette.

The screen to select the number of recorded pixels appears.

3 Use to select the number of recorded pixels and press **OK**.

You can select an image size smaller than that of the original image.

The save confirmation screen appears.



4 Select **[Save]** and press **OK**.

Cropping Out Part of the Image (Cropping)

Crops out only the desired area of the selected image and saves it as a new file.

1 Display the image to edit in single image display.

2 Select in the playback mode palette.

The cropping frame to specify the size and position of the area to crop appears on the screen.

3 Specify the size and position of the area to crop by using the cropping frame.



Available operations



Changes the size of the cropping frame.



Moves the cropping frame.



Changes the aspect ratio or Image Rotation setting.



Rotates the cropping frame (only when possible).

4 Press **OK**.

The save confirmation screen appears.

5 Select **[Save]** and press **OK**.

Correcting Color Moiré

Reduces color moiré in images.

1 Display the image to edit in single image display.

2 Select  in the playback mode palette.
If the image cannot be edited, [This image cannot be processed] appears.

3 Use   to select the correction level and press .

The save confirmation screen appears.



4 Select [Save] and press .

⚠ Caution

- The Color Moiré Correction function can be used only for the JPEG images captured with this camera.

Processing Images with Digital Filters

1 Display the image to edit in single image display.

2 Select  in the playback mode palette.
The screen to select a digital filter appears.

3 Select a filter.
Use  to select a different image.



Base Parameter Adj	Sketch
Extract Color	Water Color
Replace Color	Pastel
Toy Camera	Posterization
Retro	Miniature
High Contrast	Soft
Shading	Starburst
Invert Color	Fish-eye
Unicolor Bold	Slim
Bold Monochrome	Monochrome
Tone Expansion	

Proceed to Step 7 if you do not need to change the parameters.

4 Press .

The parameter setting screen appears.

5 Set the parameters.

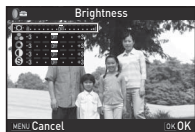

Available operations

▲▼ Selects a parameter.

◀▶ Adjusts the value.

6 Press **OK**.

The screen of Step 3 reappears.

7 Press **OK**.

The save confirmation screen appears.

8 Select **[Apply additional filter(s)]** or **[Save]** and press **OK**.

Select **[Apply additional filter(s)]** when you want to apply additional filters to the same image. The screen of Step 3 reappears.

⚠ Caution

- Only JPEG and RAW images captured with this camera can be edited with the digital filters.

📄 Memo

- Up to 20 filters, including the digital filter used during shooting (p.73), can be applied to the same image.

Recreating Filter Effects

Retrieves the filter effects of the selected image and applies the same filter effects to other images.

1 Display a filter-processed image in single image display.

2 Select **[Recreating filter effects]** in the playback mode palette.

3 Select **[Recreating filter effects]** and press **OK**.

The filter effects used for the selected image appear.

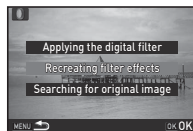

4 To check the parameter details, press **INFO**.

Press **INFO** again to return to the previous screen.



5 Press **OK**.

The image selection screen appears.

6 Use **[Recreating filter effects]** to select an image for applying the same filter effects, and press **OK**.

You can only select an image that has not been processed with a filter.

The save confirmation screen appears.



7 Select [Save] and press **OK**.

Memo

- If [Searching for original image] is selected in Step 3, the original image prior to digital filter application can be retrieved.

Editing Movies

1 Display the movie to edit in single image display.

2 Select in the playback mode palette.

The movie editing screen appears.





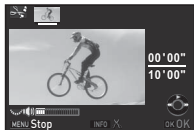

3 Select the point where you want to divide the movie.

The frame at the dividing point is displayed at the top of the screen.

Up to four points can be selected to divide the original movie into five segments.



Available operations

	Plays back/pauses a movie.
	Forwards a frame (when paused).
Press and hold 	Fast-forwards playback.
	Reverses a frame (when paused).
Press and hold 	Fast-reverses playback.
	Adjusts the volume.
	Confirms/cancels a dividing point.

Proceed to Step 7 if you do not want to delete any segment.

4 Press .

The screen to select the segments to delete is displayed.

5 Use to move the selection frame and press **OK**.

The segments to delete are specified. (Multiple segments can be deleted at once.)

Press **OK** again to cancel the selection.

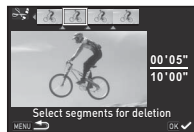

6 Press **MENU**.

The screen of Step 3 reappears.

7 Press **OK**.

The save confirmation screen appears.

8 Select [Save] and press **OK**.

Caution

- Select dividing points in chronological order from the beginning of the movie. When canceling the selected dividing points, cancel each of them in reverse order (from the end of the movie to the beginning). In an order other than specified, you can neither select dividing points nor cancel the selections of the dividing points.

Developing RAW Images

You can develop RAW images into JPEG images, and save them as new files.

1 Select **RAW** in the playback mode palette.

The screen for selecting a RAW image processing option appears.

2 Select the desired option and press **OK**.

Select single image	Develops an image.
Select multiple images	Develops up to 500 images with the same settings.
Select a folder	Develops up to 500 images in the selected folder with the same settings.

When [Select single image] is selected, proceed to Step 6. The image/folder selection screen appears.

3 Select the image(s) or a folder.

Refer to Step 2 of “Deleting Selected Images” (p.78) for how to select the image(s).

4 Press **INFO**.

The screen for selecting the parameter setting method appears.

5 Select the parameter setting method and press **OK**.

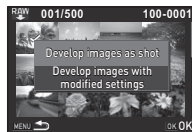





Develop images as shot	Allows you to change Image Capture Settings (JPEG Recorded Pixels and JPEG Quality).
Develop images with modified settings	Allows you to change Image Capture Settings (Aspect Ratio, JPEG Recorded Pixels, JPEG Quality, Color Space), Lens Correction (Distortion Correction, Peripheral Illumin. Corr., Lat-Chromatic-Ab Adj, Diffraction Correction, Color Fringe Correction), Digital Filter, White Balance, Custom Image, Clarity Enhancement, Sensitivity, High-ISO NR, and Shadow Correction.

6 Set the parameters.



Available operations

- | | |
|---|---|
|  | Selects a parameter. |
|  | Changes the value. |
|  | Selects a different image (when in single image display). |
-

For Image Capture Settings and Lens Correction, press  and use  to select an item.

For Digital Filter, White Balance, and Custom Image, press  to display the setting screen.

7 Press **OK**.

The save confirmation screen appears.

8 Select **[Save]** and press **OK**.

When [Select single image] is selected, select [Continue] or [Exit], and press **OK**.

Caution

- Only RAW images captured with this camera can be developed.
- The parameters [Digital Filter] and [Clarity Enhancement] cannot be set at the same time.

Memo

- When [Select multiple images] or [Select a folder] is selected in Step 2, a folder with a new number is created, and the JPEG images are stored in it.
- With the provided software “Digital Camera Utility 5”, you can develop RAW files on a computer.



Enabling the Wi-Fi Function

This camera has a built-in Wi-Fi function. By directly connecting to a communication device such as a smartphone or tablet via wireless LAN, the camera can be operated from the communication device and images can be shared with others via social networks or e-mail.

The Wi-Fi function is disabled at the time of turning the camera on. Enable the function using one of the following methods.

- Setting from the menus (p.89)
- Pressing the self-portrait shutter button (p.90)
- Touching a communication device (p.90)

Memo

- When the Wi-Fi function is enabled, the  (white) icon indicating the wireless LAN status is displayed on the status screen and Live View screen. When  (gray) is displayed, a connection with the access point was not made correctly.
- Even after the Wi-Fi function is enabled, it is disabled again when the camera is turned off and on again. Also, when the camera enters  mode, the Wi-Fi function is disabled.
- Auto Power Off is not available while a Wi-Fi connection is established or images are being transferred. If Auto Power Off is activated while a connection is not established or during standby, the Wi-Fi function is disabled. The function is enabled when the camera recovers from Auto Power Off.
- The Wi-Fi function is disabled during the USB connection.

Caution

- Do not attempt to use the Wi-Fi function in a location where the use of wireless LAN devices is restricted or prohibited, such as on airplanes.
- When using the Wi-Fi function, please observe local laws and regulations governing radio communication.
- If a memory card with a built-in wireless LAN function (such as an Eye-Fi card or a Flucard) is used, radio wave interference may occur. When this occurs, disable the Wi-Fi function of the camera.

Setting from the Menu

1 Select **[Wi-Fi]** in  **3** menu and press **▶**.

The [Wi-Fi] screen appears.

2 Set **[Action Mode]** to **[ON]**.

Select **[OFF]** to disable the Wi-Fi function.

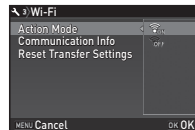

3 Press **MENU** twice.

Memo

- In Step 2, select [Communication Info] to check the SSID, Password, and MAC Address of the wireless LAN. Or, select [Reset Transfer Settings] to reset the settings to their default values.

Pressing the Self-portrait Shutter Button

- 1 Press and hold the self-portrait shutter button.**
A beep sounds and [Wi-Fi enabled] appears on the screen.

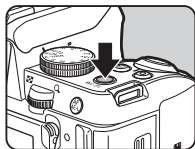

- 2 Release the self-portrait shutter button.**
To disable the Wi-Fi function, press and hold the self-portrait shutter button again.

⚠ Caution

- When the self-portrait shutter button lamp is lit green or red, it functions as the shutter release button. In such cases, use another method to turn the Wi-Fi function on or off.

Touching a Communication Device

When this camera comes into contact with a communication device equipped with the NFC function, the camera establishes a Wi-Fi connection. (p.91)

- 1 Lightly touch the communication device to the NFC mark of the camera.**

A beep sounds and [Wi-Fi enabled] appears on the screen.

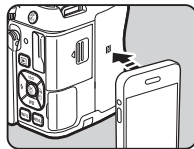

⚠ Caution

- To establish a Wi-Fi connection by touching a communication device, the Wi-Fi function and the NFC reader/writer function of the device must be enabled in advance. For details on how to operate the communication device, refer to the operating manual of the device.

📄 Memo

- When the dedicated application "Image Sync" is installed on the communication device, the Wi-Fi function is enabled and Image Sync is started at the same time by touch operation. (p.94) When Image Sync is not installed, the download site for the application is displayed on the communication device.

Operating the Camera with a Communication Device

The following functions can be used by directly connecting the camera to a communication device via Wi-Fi and using the dedicated application "Image Sync".

Remote Capture	Displays the Live View image of the camera on the communication device, and then enables controlling the exposure settings and shooting by operating the communication device.
Image View	Displays the images saved on the memory card inserted in the camera on the communication device and imports the images to the communication device.

Image Sync supports iOS and Android. Image Sync can be downloaded from the App Store or Google Play Store. For supported OS and other details, refer to the download site.

Memo

- The Image Sync screenshots used in this manual are the ones under development and may differ from the actual display. The screen layout and elements may be also changed due to causes such as the version upgrade of the application.
- For details on how to operate the communication device, refer to the operating manual of the device.

Connecting the Camera and Communication Device

Connect the camera and communication device via Wi-Fi, and start Image Sync installed on the communication device.

When an NFC-compatible Device is Used

- 1 Set the wireless LAN (Wi-Fi) function and the NFC reader/writer function to ON on the communication device.**
- 2 Lightly touch the communication device to the NFC mark of the camera.**

A Wi-Fi connection is established between the camera and communication device.

Image Sync is started, and the list of images appears.

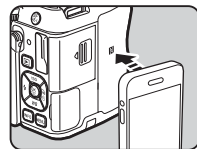

When a Non-NFC-compatible Device is Used

- 1 Set the wireless LAN (Wi-Fi) function to ON on the communication device.
- 2 Start Image Sync on the communication device.
The [Choose a Network] screen appears on the communication device.
- 3 Tap [PENTAX_xxxxxx] in the [Network List].
The [Enter Password] screen appears.



- 4 Enter the password, and tap [Connect].

A Wi-Fi connection is established between the camera and communication device.

The list of images appears on the Image Sync screen.

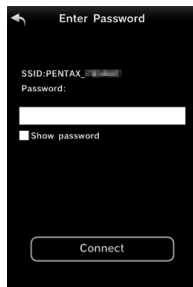

Memo

- Refer to [Communication Info] in [Wi-Fi] of the  3 menu for the default password. (p.89)

When an iOS Device is Used

1 Set the wireless LAN (Wi-Fi) function to ON on the communication device.

Tap [PENTAX_XXXXXX] in the list of detected Wi-Fi networks.

2 Enter the password, and tap [Join].

A Wi-Fi connection is established between the camera and communication device.



3 Start Image Sync on the communication device.

Image Sync is started, and the list of images appears.

Screens of “Image Sync”

Flick left or right on the screen to change screens.

Application image list

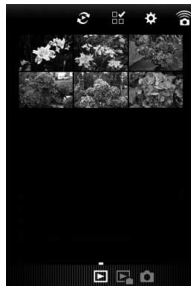

Camera image list



Camera mode



Memo

- You can also change screens by tapping the buttons displayed at the bottom of each screen.

Shooting with a Communication Device

The Live View image of the camera and buttons for shooting are displayed on the shooting screen of Image Sync.

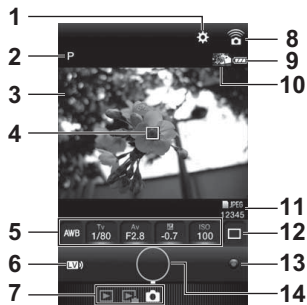

- 1 Settings (p.98)
- 2 Capture mode
- 3 Live View
- 4 AF frame
- 5 White Balance, Shutter Speed, Aperture value, EV Compensation, Sensitivity
- 6 Live View on/off
- 7 Operation modes
- 8 NFC connection screen
- 9 Battery level
- 10 Thumbnail of the last captured image (When tapped, the camera image list is displayed.)
- 11 File Format, Image storage capacity
- 12 Drive Mode
- 13 Green button
- 14 Shutter button

Shooting Images

- 1 Configure the basic settings on the camera.
- 2 Check the Live View image on the shooting screen of Image Sync.
- 3 Change the settings using Image Sync as necessary.



Tap an item and select a value from the list.

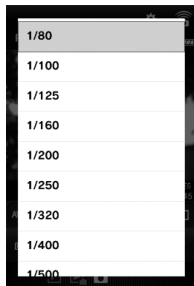

4 When the focus mode is set to **AF**, tap an area where you want to perform autofocus in the Live View image.

Autofocus is performed on the tapped area.

5 Tap the shutter release button.

The captured image is displayed as a thumbnail.

⚠ Caution

- Shooting with Image Sync is not available in the following situations.
 - When the drive mode is set to other than [Single Frame Shooting]
 - In  mode
 - When the camera is connected to a device via USB or HDMI terminal
 - When using the ASTROTRACER function
- The captured images are saved to the memory card inserted in the camera and to the communication device with Image Sync. Shooting cannot be performed if there is not enough available space on the memory card.

📌 Memo

- Shooting can also be performed by tapping the Live View image. Set in [Touch AF] on the [Settings] screen. (p.98)

Viewing Images

You can view the images saved either in the camera or in the communication device.

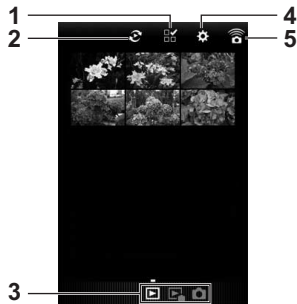

- 1 Multiple image selection button
- 2 Album selector button (available for the application image list only)
- 3 Operation modes
- 4 Settings (p.98)
- 5 NFC connection screen

Tap the image to display the full-screen image and shooting information.

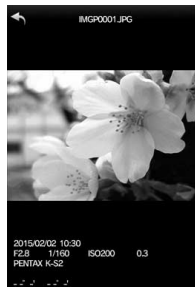

Touch operations

Flick left/right	Shows the previous/next image.
Pinch out/in	Magnifies/Reduces the image.

Selecting the Image Storage Location

When viewing images in application image list display, you can select the image storage location (album) from [Application] or [Gallery] (or [Camera Roll]).

1 Tap .

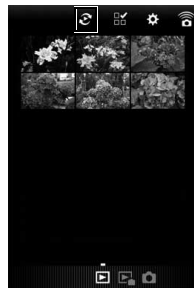

2 Select the album.

The images in the selected album are displayed.

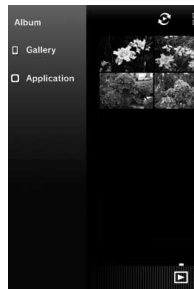

Selecting Multiple Images

1 Tap .

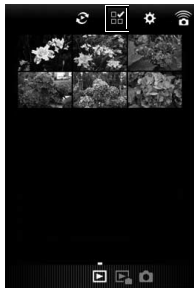

2 Tap the images to select.
Blue check marks appear.

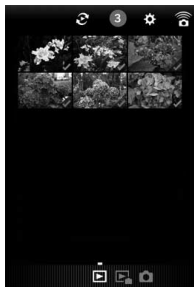

3 Touch and hold one of the selected images.

4 Select the desired action.



Memo

- When you touch and hold the desired image shown in list display or shooting information display, the same screen as Step 4 appears and you can select the action to apply.

Changing the Settings

1 Tap .



The [Settings] screen appears.

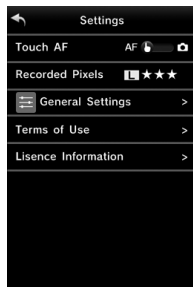

The following settings are available.

Touch AF	Sets whether to perform only autofocus or perform shooting after autofocus when touching the Live View image.
Recorded Pixels	Changes the number of recorded pixels and the quality level.
General Settings	Changes the communication settings and the display language.

2 Tap [General Settings] if you change the communication settings and the display language.

3 Tap the setting item to be changed.

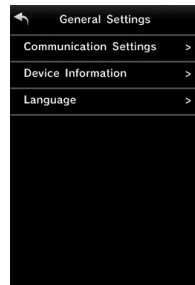

Communication Settings

The password and wireless channel can be changed.



Device Information

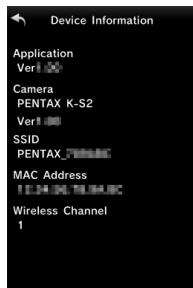

Language

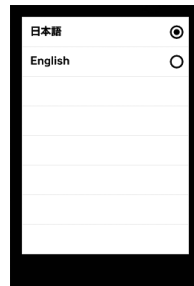

4 Change the settings and tap ←.

Camera Settings

Customizing the Button/E-dial Functions



Setting the E-dial Operation

For each exposure mode, you can set the functions for when and are turned and is pressed.

- 1 Select **[E-Dial Programming]** in menu and press .

The [E-Dial Programming] screen appears.

- 2 Select an exposure mode and press .

The screen for the selected exposure mode appears.

- 3 Press and use to select the combination of functions for when and are turned and is pressed.

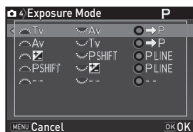

Tv	Change Shutter Speed
Av	Change Aperture Value
ISO	Change Sensitivity
	EV Compensation
P	Return to P Mode

PSHIFT	Program Shift
PLINE	Program Line
--	Not available

- 4 Press **OK**.

- 5 Press **MENU**.

The [E-Dial Programming] screen reappears. Repeat Steps 2 to 5.

- 6 Press **MENU** twice.

Memo

- If you select [Rotation Direction] in Step 2, you can reverse the effect obtained by turning or .

Setting the Button Operation

Set the functions for **[RAW/Fx]**, **[AF/AE-L]**, and the self-portrait shutter button.

- 1 Select **[Button Customization]** in menu and press .

The [Button Customization] screen appears.

- 2 Select the desired item and press .

The screen to set the function for the selected item is displayed.

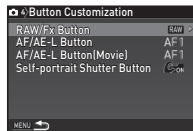

3 Press **▶** and use **▲▼** to select the functions to assign.

The following functions can be assigned to each button.

	Setting	Function	Page
RAW/Fx Button	One Push File Format	Temporarily changes the file format.	p.102
	Bracketing	Sets Bracketing shooting.	p.62
	Optical Preview	Activates the Optical Preview to check the depth of field with the viewfinder.	p.48
	Digital Preview	Activates the Digital Preview to check the composition, exposure and focus on the monitor. (The maximum display time: 60 seconds) You can magnify or save the preview image.	
	Shake Reduction	Turns the Shake Reduction and Movie SR functions on/off.	-
	AF Active Area	Enables changing the AF point.	p.56

	Setting	Function	Page
AF/AE-L Button	Enable AF1	Autofocus is performed when AF/AE-L is pressed.	p.54
	Enable AF2	Autofocus is performed when AF/AE-L is pressed and not when SHUTTER is pressed halfway.	
	Cancel AF	While AF/AE-L is pressed, the autofocus mode is set to MF . Half press of SHUTTER is disabled.	
	AE Lock	Locks the exposure setting.	p.49
Self-portrait Shutter Button	ON	Functions as the shutter release button when the LCD screen is pointed toward the subject.	p.41
	OFF	Always functions as the button to turn on/off Wi-Fi.	p.90

4 Press **OK**.

5 Press **MENU**.

The screen of Step 2 reappears.
Repeat Steps 2 to 5.

6 Press **MENU** twice.

Setting the One Push File Format

Select the file format to change to when **RAW/Fx** is pressed for each [File Format] setting.

- 1 Set [RAW/Fx Button] to [One Push File Format] in Step 3 of “Setting the Button Operation” (p.100).
- 2 Select or for [Cancel after 1 shot].

<input checked="" type="checkbox"/>	The recording format returns to the original file format after a picture is taken.
<input type="checkbox"/>	The setting is retained until any of the following operations is performed: <ul style="list-style-type: none"> • When RAW/Fx is pressed again • When ▶ or MENU is pressed, or when the mode dial or main switch is turned

- 3 Select the file format when **RAW/Fx** is pressed.

The left side is the [File Format] setting and the right side is the changed file format when **RAW/Fx** is pressed.

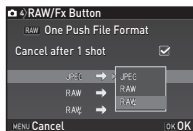

Selecting the Display Settings for Digital Preview

Select the camera operation and type of information displayed on the monitor when Digital Preview is displayed by pressing **RAW/Fx**.

- 1 Set [RAW/Fx Button] to [Digital Preview] in Step 3 of “Setting the Button Operation” (p.100).
- 2 Press **▼** and select or for each display item.



Saving Frequently Used Settings



Camera settings can be saved to **U1** and **U2** of the mode dial and used repeatedly.

The following settings can be saved.

Exposure Mode (P/Sv/ Tv/Av/TAv/M/B)	Drive Mode
Sensitivity	White Balance
EV Compensation	☑ 1-4 menu settings (with exceptions)
AF point	C1-4 menu settings
Flash Mode	

Saving the Settings

1 Set the exposure mode and all of the settings to save.

2 Select [Save USER Mode] in 4 menu and press **▶**.

The [Save USER Mode] screen appears.

3 Select [Save Settings] and press **▶**.

The [Save Settings] screen appears.

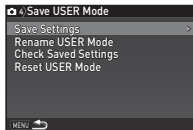

4 Select [USER1] or [USER2] and press **▶**.

5 Select [Save] and press **OK**.

The screen of Step 3 reappears.

⚠ Caution

- [Save USER Mode] cannot be selected when the mode dial is set to **AUTO**, **SCN**, or **A-HDR**.

📝 Memo

- The settings saved as the USER mode can be displayed on the monitor when you select [Check Saved Settings] in Step 3.
- To reset the settings to the default values, select [Reset USER Mode] in Step 3.

Editing a Setting Name

You can change the name of the USER mode in which you saved settings.

1 Select [Rename USER Mode] in Step 3 of “Saving the Settings” (p.103) and press **▶**.

The [Rename USER Mode] screen appears.

2 Select [USER1] or [USER2] and press **▶**.

The text-entry screen appears.



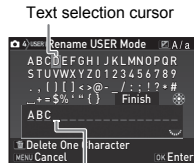

3 Change the text.

Up to 18 single-byte alphanumeric characters and symbols can be entered.



Text input cursor

Available operations

	Moves the text selection cursor.
	Moves the text input cursor.
	Switches between upper and lower case letters.
	Enters a character selected with the text selection cursor at the position of the text input cursor.
	Deletes a character at the position of the text input cursor.

4 After entering the text, move the text selection cursor to [Finish], and press **OK**.

The [Rename USER Mode] screen reappears.

Using the Saved USER Mode

1 Set the mode dial to U1 or U2.

The USER mode guide is displayed for about 3 seconds. Use **▲▼** to check the saved settings.

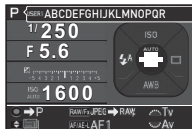

2 Change the settings as necessary.

The exposure mode can be changed in [Exposure Mode] of the 1 menu.

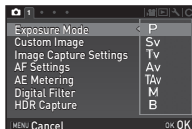

Memo

- The settings changed in Step 2 are not saved as the USER mode settings. When the camera is turned off, the camera returns to the originally saved settings. To change the original settings, save the USER mode settings again.

Displaying the Local Date and Time of the Specified City

1



The date and time set at the time of initial setting ("Initial Settings" (p.36)) serve as the date and time of your present location and are reflected in the shooting date and time for images.

Setting the destination to a location other than your present location enables you to display the local date and time on the monitor when traveling abroad and also save images time-stamped with the local date and time.

1 Select [World Time] in 1 menu.

The [World Time] screen appears.

2 Select the time you wish to display in [Time Setting].

Select  (Hometown) or  (Destination).

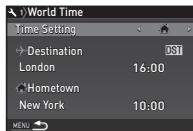

3 Select [Destination] and press .

The [ Destination] screen appears.

4 Use to select a city.

Use  to change the region.

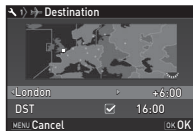



5 Select [DST] (daylight saving time), and use to select or .

6 Press .

The screen of Step 2 reappears.

7 Press twice.

Memo

- Refer to "List of World Time Cities" (p.128) for cities that can be selected as a hometown or destination.
- Select [ Hometown] in Step 3 to change the city and DST settings for the hometown.
-  appears in the control panel when [Time Setting] is set to .

Selecting Settings to Save in the Camera

4

Most of the functions set on this camera are saved even if the camera is turned off. For the following function settings, you can select whether to save the settings () or to return the settings to their default values () when the camera is turned off. Set in [Memory] of the  4 menu.

Flash Mode	Flash Exposure Compensation
Drive Mode	Digital Filter
White Balance	HDR Capture
Custom Image	Clarity Enhancement
Sensitivity	Shooting Info Display
EV Compensation	Playback Info Display

Memo

- When [Reset] of the  3 menu is performed, all Memory settings return to the default values.

File Management Settings

Protecting Images from Deletion (Protect)

You can protect images from being accidentally deleted.

⚠ Caution

- Even protected images are deleted if the inserted memory card is formatted.

1 Select **☰** in the playback mode palette.

The screen for selecting the unit for processing appears.

2 Select [Select image(s)] or [Select a folder] and press **OK**.



3 Select the image(s) or folder to protect.

Refer to Step 2 of "Deleting Selected Images" (p.78) for how to select the image(s).

Proceed to Step 5 if [Select a folder] is selected.

4 Press **INFO**.

The confirmation screen appears.

5 Select [Protect] and press **OK**.

📝 Memo

- To protect all images stored in the memory card, select [Protect All Images] of the **▶1** menu.

Selecting the Folder/File Settings



Folder Name

When images are captured with this camera, a folder is automatically created and the captured images are stored in it. Each folder name consists of a sequential number from 100 to 999 and a string of 5 characters.

The folder name can be changed.

1 Select [Folder Name] in **↶2** menu and press **▶**.

The [Folder Name] screen appears.

2 Select a folder name and press **OK**.

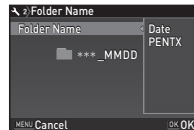

Date	The two digits of the month and day on which the picture was taken are assigned after the folder number. The month and day appear according to the date format set in [Date Adjustment]. Example) 101_0125: for images taken on January 25th
PENTX	The character string "PENTX" is assigned after the folder number. The character string can be changed arbitrarily. Example) 101PENTX

Proceed to Step 6 if you selected [Date] or do not need to change the character string from "PENTX".

- 3** Press **▼**, and then press **▶**.
The text-entry screen appears.

- 4** **Change the text.**
Enter 5 single-byte alphanumeric characters.

Text selection cursor



Text input cursor

Available operations



Moves the text selection cursor.



Moves the text input cursor.



Enters a character selected with the text selection cursor at the position of the text input cursor.



Resets the entered text to "PENTX".

- 5** After entering the text, move the text selection cursor to **[Finish]**, and press **OK**.
The screen of Step 2 reappears.

- 6** Press **MENU** twice.

Memo

- A folder with a new number is created when the folder name is changed.
- A maximum of 500 images can be stored in a single folder. When the number of captured images exceeds 500, a new folder is created with the number following the number of the folder currently being used. In Bracketing shooting, images are stored in the same folder until shooting is completed.

Caution

- The maximum folder number is 999. After the folder number reaches 999, you cannot capture new images if you attempt to change the folder name or create a new folder, or when the file name number reaches 9999.

Create New Folder

When [Create New Folder] is selected in the menu, a folder is created with a new number when the next image is saved.

Caution

- You cannot successively create multiple folders.

Memo

- A new folder is automatically created in the following cases.
 - When the drive mode is set to [Interval Shooting] (p.64)
 - When the drive mode is set to [Interval Composite] and [Save Process] is set to [On] (p.65)
 - When [Select multiple images] or [Select a folder] is selected for [RAW Development] (p.87)

File Name

One of the following string of characters is used as the file name prefix depending on the [23 Color Space] setting of the **C4** menu.

Color Space	File Name
sRGB	IMGPxxxx.JPG
AdobeRGB	_IMGxxxx.JPG

The first four characters can be changed to a character string of your choice.

1 Select [File Name] in **2** menu and press **▶**.

The [File Name] screen appears.

2 Select or and press **▶**.

The text-entry screen appears.



3 Change the text.

Up to 4 single-byte alphanumeric characters can be entered.

Refer to Steps 4 and 5 of “Folder Name” (p.106) for how to enter text.

4 Press **MENU** twice.

Memo

- When [Color Space] is [AdobeRGB], the file name prefix is “_” and first three characters of the entered character string becomes the file name.
- For movies, regardless of the [Color Space] setting, the file name is “IMGPxxxx.MOV” or the one with the entered string of characters.

File No.

Each file name consists of a string of 4 characters and a sequential number from 0001 to 9999. You can set whether to continue the sequential numbering for the file name even if a new folder is created in [Sequential Numbering] of [File No.] in the **2** menu.

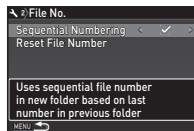

<input checked="" type="checkbox"/>	Continues the sequential numbering for the file name even if a new folder is created.
<input type="checkbox"/>	Returns the file number of the first image saved to a folder to 0001 each time a new folder is created.

Select [Reset File Number] to reset the file number to its default value.

Memo

- When the file number reaches 9999, a new folder is created and the file number is reset.

Setting the Copyright Information



Sets the photographer and copyright information embedded in the Exif data.

1 Select [Copyright Information] in 2 menu and press .

The [Copyright Information] screen appears.

2 Use to set [Embed Copyright Data].



<input type="checkbox"/>	Does not embed copyright information in the Exif data.
<input checked="" type="checkbox"/>	Embeds copyright information in the Exif data.

3 Select [Photographer] or [Copyright Holder], and press .

The text-entry screen appears.

4 Change the text.

Up to 32 single-byte alphanumeric characters and symbols can be entered.

Text selection cursor

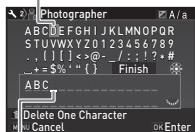

Text input cursor

Available operations



Moves the text selection cursor.



Moves the text input cursor.



Switches between upper and lower case letters.



Enters a character selected with the text selection cursor at the position of the text input cursor.



Deletes a character at the position of the text input cursor.

5 After entering the text, move the text selection cursor to [Finish], and press .

The screen of Step 2 reappears.

6 Press twice.









Memo

- The Exif information can be checked using the provided software "Digital Camera Utility 5".

Restrictions on Each Capture Mode

#: Restricted X: Not available

Function	Capture Mode	SCN									A-HDR	B	
	AUTO												
Sensitivity							X	X		X		*1	# ²
Flash						X	X			X	X		X
Drive Mode	Continuous Shooting						X				X	X	X
	Self-timer			X						X			X
	Remote Control			X						X			
	Bracketing			X			X		X	X	X	X	X
	Multi-exposure			X			X		X	X	X		X
	Interval Shooting			X						X		X	X
	Interval Composite			X			X		X	X		X	X
	Interval Movie Record	X	X	X	X	X	X	X	X	X	X	X	X
Star Stream	X	X	X	X	X	X	X	X	X	X	X	X	
Focus Method	A.F.A. 	A.F.S. 	A.F.S. ^{*3}	A.F.C. ^{*3}	A.F.S. 	A.F.S. ^{*3}	A.F.S. ^{*3}	A.F.C. ^{*3}	A.F.C. 	A.F.C. ^{*3}			
File Format RAW/RAW+							X				X		X

Function	Capture Mode	SCN									A-HDR	B	
		AUTO											
Shake Reduction							On ^{*3}					×	
White Balance	AWB ^{*3}	AWB ^{*3}	AWB ^{*3}	AWB ^{*3}	AWB ^{*3}	AWB ^{*3}	AWB ^{*3}	AWB ^{*3}	AWB ^{*3}	AWB ^{*3}			
Custom Image	× ^{*5}	× ^{*5}	× ^{*5}	× ^{*5}	× ^{*5}	× ^{*5}	× ^{*5}	× ^{*5}	× ^{*5}	× ^{*5}			
Digital Filter							×				×		
HDR Capture				×			× ^{*6}		×		× ^{*6}	×	# ^{*7}
AA Filter Simulator				# ^{*8}			×		# ^{*8}		×	# ^{*8}	×
Save RAW Data				×					×				×

*1 [ISO AUTO] is not available.

*2 Can be set from ISO 100 to ISO 3200 only when the capture mode is set to .

*3 Fixed to; the setting cannot be changed.

*4 Limited to; available settings are limited.

*5 Fixed to a specific setting; the setting cannot be changed.

*6 Specific settings are used.

*7 Available only when the drive mode is set to [Interval Movie Record].

*8 [Bracketing] is not available.

Restrictions on the Combinations of Special Functions

#: Restricted x: Not available

		Digital Filter	HDR Capture	Clarity Enhancement	Lens Correction	AA Filter Simulator
Flash			x			
Drive Mode	Continuous Shooting		x			# ^{*2}
	Bracketing		x			# ^{*2}
	Multi-exposure	x	x	x	x	# ^{*2}
	Interval Shooting	# ^{*1}	# ^{*1}	# ^{*1}		# ^{*2}
	Interval Composite	x	x	x	x	# ^{*2}
	Interval Movie Record	# ^{*1}	# ^{*1}	# ^{*1}	x	x
	Star Stream	x	x	x	x	x
File Format RAW/RAW+			x			
Digital Filter			x	x		
HDR Capture		x				x

*1 There is a restriction on the minimum value for [Interval].

*2 [Bracketing] is not available.

Functions Available with Various Lenses

All capture modes are available when a DA, DA L, or FA J lens is used, or when a lens with an **A** position is used with the aperture ring set to the **A** position.

When other lenses than above are used, or a lens with **A** position is used in a position other than **A**, the following restrictions apply.

✓: Available #: Restricted ✗: Not available

Function	Lens [Mount type]	DA DA L D FA	FA J FA *6	F *6	A	M P
		[KAF] [KAF2] [KAF3]	[KAF] [KAF2]	[KAF]	[KA]	[K]
Autofocus (Lens only) (With AF adapter 1.7x) *1		✓ –	✓ –	✓ –	– #	– #
Manual focus (With focus indicator) *2 (With matte field)		✓	✓	✓	✓	✓
Quick-shift focus		#*4	✗	✗	✗	✗
Focus point selection mode [Auto]		✓	✓	✓	#*8	✗
AE Metering [Multi-segment]		✓	✓	✓	✓	✗
P/Sv/Tv/Av/TAv mode		✓	✓	✓	✓	#*9
M mode		✓	✓	✓	✓	#
P-TTL auto flash *3		✓	✓	✓	✓	✗
Automatic obtaining of the lens focal length information		✓	✓	✓	✗	✗
Lens Correction		✓*5	✗*7	✗	✗	✗

- *1 Lenses with a maximum aperture of F2.8 or faster. Only available at the **A** position.
- *2 Lenses with a maximum aperture of F5.6 or faster.
- *3 Available when using the built-in flash, AF540FGZ, AF540FGZ II, AF360FGZ, AF360FGZ II, AF200FG, or AF160FC.
- *4 Only available with compatible lenses.
- *5 Distortion Correction and Peripheral Illumination Correction are disabled when a DA FISH-EYE 10-17mm lens is used.
- *6 To use an FA SOFT 28mm F2.8 lens, FA SOFT 85mm F2.8 lens, or F SOFT 85mm F2.8 lens, set [28 Using Aperture Ring] to [Enable] in the **C4** menu. Pictures can be taken with the aperture you set, but only within a manual aperture range.
- *7 Only available with an FA 31mm F1.8 Limited, FA 43mm F1.9 Limited, or FA 77mm F1.8 Limited lens.
- *8 Fixed to [Spot].
- *9 **Av** with the aperture set to wide open. (The aperture ring has no effect on the actual aperture value.)

⚠ Caution

- When the aperture ring is set to a position other than **A** or a lens without an **A** position or accessories such as an auto extension tube or auto bellows are used, the camera does not operate unless [28 Using Aperture Ring] is set to [Enable] in the **C4** menu. Refer to “Using the Aperture Ring” (p.115) for details.
- When a retractable lens is attached and is not extended, you cannot take pictures and use some functions. If the lens is retracted during shooting, the camera stops working.

Lens Names and Mount Names

DA lenses with a motor and FA zoom lenses with power zoom use the KAF2 mount. (Of these lenses, the lenses without an AF coupler use the KAF3 mount.)

FA single focal length lenses (non-zoom lenses), DA or DA L lenses without a motor, and D FA, FA J and F lenses use the KAF mount. (The power zoom function is not compatible with this camera.)

Refer to respective lens manuals for details.

Compatibility with the Built-in Flash

Depending on the lens being used, the use of the built-in flash may be limited.

Lens	Restrictions when using the built-in flash
DA FISH-EYE 10-17mm F3.5-4.5 ED [IF]/ DA 12-24mm F4 ED AL/ DA 14mm F2.8 ED [IF]/ DA 15mm F4 ED AL/ FA★300mm F2.8 ED [IF]/ DA★560mm F5.6 ED AW/ FA★600mm F4 ED [IF]/ FA★250-600mm F5.6 ED [IF]	The built-in flash is not available due to vignetting.
F FISH-EYE 17-28mm F3.5-4.5	Vignetting may occur if the focal length is less than 20 mm.
DA 16-45mm F4 ED AL	When the focal length is less than 28 mm, or when the focal length is 28 mm and the shooting distance is 1 m or less, vignetting may occur.
DA★16-50mm F2.8 ED AL [IF] SDM	When the focal length is 20 mm or less, or when the focal length is 35 mm and the shooting distance is less than 1.5 m, vignetting may occur.
DA 16-85mm F3.5-5.6 ED DC WR	When the focal length is 24 mm or less and the shooting distance is 0.8 m or less, vignetting may occur.

Lens	Restrictions when using the built-in flash
DA 17-70mm F4 AL [IF] SDM	When the focal length is less than 24 mm, or when the focal length is 35 mm and the shooting distance is 1 m or less, vignetting may occur.
DA 18-250mm F3.5-6.3 ED AL [IF]	Vignetting may occur if the focal length is less than 35 mm.
DA 18-270mm F3.5-6.3 ED SDM	Vignetting may occur if the focal length is less than 24mm.
FA★28-70mm F2.8 AL	Vignetting may occur if the focal length is 28 mm and the shooting distance is less than 1 m.
FA SOFT 28mm F2.8/ FA SOFT 85mm F2.8	The built-in flash always discharges fully.

Using the Aperture Ring

C4

The shutter can be released even if the aperture ring of the D FA, FA, F or A lens is not set to the **A** position or a lens without an **A** position is attached.

Select [Enable] in [28 Using Aperture Ring] of the **C4** menu.

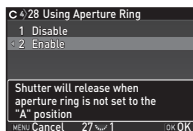

The following restrictions apply depending on the lens being used.

Lens	Restriction
D FA, FA, F, A, M (lens only or with automatic diaphragm accessories such as auto extension tube K)	The aperture remains open. The shutter speed changes in relation to the open aperture but an exposure deviation may occur.
D FA, FA, F, A, M, S (with diaphragm accessories such as extension tube K)	Pictures can be taken with a set aperture value but an exposure deviation may occur.
Manual diaphragm lens such as reflex lens (lens only)	
FA SOFT 28mm/ FA SOFT 85mm/ F SOFT 85mm (lens only)	Pictures can be taken with a set aperture value in the manual aperture range.

Memo

- If the aperture ring is set to a position other than **A**, the camera operates in **Av** mode regardless of the mode dial setting except when set to **M** or **B** mode.
- [F--] appears for the aperture indicator in the status screen, Live View screen and viewfinder.

How to Achieve the Correct Exposure with the Aperture Ring Not Set to A

The correct exposure can be achieved by the following procedures when the aperture ring is not set to **A**.

- Set the mode dial to **M**.
- Set the aperture ring to the desired aperture.
- Press **O**.
The correct shutter speed will be set.
- If the correct exposure cannot be achieved, adjust the ISO sensitivity.

Setting the Focal Length



The Shake Reduction function operates by obtaining lens information such as focal length. Set the focal length when using a lens that the focal length information cannot be automatically obtained.

1 Set [28 Using Aperture Ring] to [Enable] in the C4 menu.

2 Turn the camera off.

3 Attach a lens to the camera and turn the camera on.

The [Input Focal Length] screen appears.

4 Use ▲▼ to set the focal length.

Press ◀ to select a value from the list.

When using a zoom lens, select the actual focal length to be used for shooting.

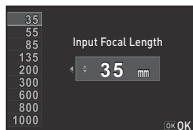

5 Press **OK**.

The camera returns to standby mode.

Memo

- The focal length setting can be changed in [Input Focal Length] of the menu.

Functions when Using an External Flash

Use of the following external flashes (optional) enables a variety of flash modes, such as P-TTL auto flash mode.

✓ : Available # : Restricted ✕ : Not available

Camera Function \ Compatible Flash	Built-in Flash	AF540FGZ AF540FGZ II AF360FGZ AF360FGZ II	AF200FG AF160FC
Red-eye reduction flash	✓	✓	✓
Auto Flash Discharge	✓	✓	✓
Automatic switch to the flash sync speed	✓	✓	✓
Automatic setting of the aperture value in P or Tv mode	✓	✓	✓
P-TTL auto flash	✓ ^{*1}	✓ ^{*1}	✓ ^{*1}
Slow-speed Sync flash	✓	✓	✓
Flash Exposure Compensation	✓	✓	✓
AF assist light of external flash	✕	✓ ^{*2}	✕
Trailing Curtain Sync flash ^{*3}	✓	✓	✕
Contrast-control-sync flash	# ^{*4}	✓	# ^{*5}
Slave flash	✕	✓	✕
High-speed Sync flash	✕	✓	✕

- *1 Available only when using a DA, DA L, D FA, FA J, FA, F, or A lens.
- *2 AF assist light is not available with the AF540FGZ or AF360FGZ.
- *3 Shutter speed of 1/90 seconds or slower.
- *4 When combined with the AF540FGZ, AF540FGZ II, AF360FGZ, or AF360FGZ II, 1/3 of the flash discharge can be output by the built-in flash and 2/3 can be output by the external flash.
- *5 Available only when combined with the AF540FGZ, AF540FGZ II, AF360FGZ, or AF360FGZ II.

⚠ Caution

- Never press  on the camera when any external flash unit is attached to the camera. The built-in flash will hit the external flash. If you want to use both at once, connect them using an extension cord.
- Flashes with the reversed polarity (the center contact on the hot shoe is minus) cannot be used due to the risk of damaging the camera and/or flash.
- Do not combine with accessories that have a different number of contacts, such as a Hot Shoe Grip, as a malfunction may occur.
- Combining with flashes from other manufacturers may cause equipment breakdown.

📄 Memo

- With the AF540FGZ, AF540FGZ II, AF360FGZ, or AF360FGZ II, you can use the High-speed Sync flash to discharge a flash when taking a picture at a shutter speed faster than 1/180 seconds. Set the capture mode to **Tv**, **TAv**, or **M**.

Using the GPS Unit

In addition to GPS information being saved in the shooting information of the image, the following functions are available when the optional GPS unit O-GPS1 is attached to this camera.

Electronic Compass	Displays the current latitude, longitude, altitude, direction, Coordinated Universal Time (UTC), capture mode, and exposure value. 
ASTROTRACER	Tracks and captures celestial bodies. By matching the movement of the camera's built-in Shake Reduction unit with the movement of celestial bodies, celestial bodies can be captured as individual points even when shooting with a long exposure setting. (p.118)
GPS Time Sync	Automatically adjusts the camera's date and time settings using information obtained from GPS satellites.

📄 Memo

- Refer to the manual of the GPS unit for details on how to attach the unit and information on the unit's functions.
- To display [Electronic Compass], refer to "Shooting Info Display" (p.13).

⚠ Caution

- "Simple Navigation" cannot be used with this camera.

Shooting Celestial Bodies (ASTROTRACER)



- 1 Set the mode dial to **B**.
- 2 Select **[GPS]** in **☰2** menu and press **▶**.
The **[GPS]** screen appears.
- 3 Select **[ASTROTRACER]** and press **▶**.
The **[ASTROTRACER]** screen appears.
- 4 Set **[Action in B Mode]** to  and press **OK**.

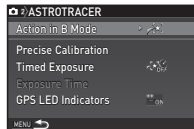











- 5 To set the desired exposure time, first set **[Timed Exposure]** to **[ON]**.
You can set the exposure time between 0'10" and 5'00" in **[Exposure Time]**.
- 6 Press **MENU** three times.
The camera returns to standby mode.
- 7 Press **SHUTTER** fully.
Shooting starts.
- 8 Press **SHUTTER** fully again.
Shooting stops.
When **[Timed Exposure]** is enabled, shooting ends automatically after the set time has elapsed.

Troubleshooting

🔧 Memo



- In rare cases, the camera may not operate correctly due to causes such as static electricity, etc. This can be remedied by taking the battery out and putting it back in again. If the camera operates correctly, it does not require any repairs.

Problem	Cause	Remedy
The camera does not turn on.	Battery is not installed properly.	Check the orientation of the battery.
	The battery power is low.	Charge the battery.
The shutter cannot be released.	The built-in flash is being charged.	Wait until charging is finished.
	There is no available space on the memory card.	Insert a memory card with available space or delete unwanted images.
	Data is being processed.	Wait until processing is finished.
	The lens aperture ring is set to a position other than A .	Set the lens aperture ring to the A position or select [Enable] in [28 Using Aperture Ring] of the C4 menu. (p.115)



Problem	Cause	Remedy
Autofocus does not work.	The subject is difficult to focus on.	AF cannot work well for low-contrast objects (the sky, white walls, etc.), dark colors, intricate designs, rapidly-moving objects or scenery shot through a window or a net-like pattern. Lock focus on another object located at the same distance as your subject, then aim at the target and take a picture. Alternatively, use MF .
	The subject is too close.	Move away from the subject and take a picture.
The focus cannot be locked.	AF Mode of Live View is set to  .	Set [Contrast AF] to  ,  ,  , or  . (p.57)
The built-in flash does not discharge.	The flash mode is set to  or  .	When the flash mode is set to  or  , the flash does not discharge if the subject is bright. Change the flash mode. (p.53)
The camera is not recognized when it is connected to a computer.	The USB connection mode is set to [PTP].	Set [USB Connection] to [MSC] in the  2 menu.
Dust or dirt particles appear in images.	The CMOS sensor is dirty or dusty.	Activate [Dust Removal] from the  4 menu. The Dust Removal function can be activated every time the camera is turned on and off. Refer to "Sensor Cleaning" (p.120) if the problem persists.

Problem	Cause	Remedy
There are visible defects in a captured image, or parts in the display monitor that do not light up or remain lit.	There are defective pixels in the CMOS sensor.	Activate [Pixel Mapping] from the  4 menu. It takes about 30 seconds to correct the defective pixels, so be sure to install a fully charged battery.

Raise the mirror up and open the shutter when cleaning the CMOS sensor with a blower.

- 1 Turn the camera off and remove the lens.**
- 2 Turn the camera on.**
- 3 Select [Sensor Cleaning] in  4 menu and press .**

The [Sensor Cleaning] screen appears.

- 4 Select [Mirror Up] and press .**
The mirror rises up and the  lamp blinks slowly.

- 5 Clean the CMOS sensor with a blower.**

- 6 Turn the camera off.**
The mirror automatically returns to its original position.

Caution

- Never use a spray blower or a blower with a brush. The CMOS sensor may be damaged. Do not wipe the CMOS sensor with a cloth.
- Do not put the tip of the blower inside the lens mount area. If the power is turned off during cleaning, this may cause damage to the shutter, CMOS sensor and the mirror. Hold the camera with the lens mount down while cleaning the sensor so dust will fall away from the sensor when the blower is used.
- When the battery level is low, the message [Not enough battery power remaining to clean sensor] is displayed on the monitor. Install a fully charged battery. If the battery capacity becomes low during cleaning, a warning beep will sound. In this case, stop cleaning immediately.

Memo

- Please contact your nearest service center for professional cleaning as the CMOS sensor is a precision part.
- You can use the optional Image Sensor Cleaning Kit O-ICK1 when cleaning the CMOS sensor.

Error Messages

Error messages	Description
Memory card full	The memory card is full and no more images can be saved. Insert a new memory card or delete unwanted files.
No image	There are no images that can be played back on the memory card.
This image cannot be displayed	You are trying to play back an image in a format not supported by this camera. You may be able to play it back on a computer.
No card in the camera	There is no memory card inserted in the camera.
Memory card error	The memory card has a problem, and image capture and playback are impossible. You may be able to play it back on a computer.
Card is not formatted	The memory card you have inserted is unformatted or has been previously used on another device and is not compatible with this camera. Use the card after formatting it with this camera.
Card is locked	The write-protect switch on the memory card you have inserted is locked. (p.138)
This image cannot be magnified	You are trying to magnify an image that cannot be magnified.
This image is protected	You are trying to delete an image that is protected. Remove the protection from the image. (p.106)

Error messages	Description
Not enough battery power remaining to activate Pixel Mapping	These messages appear when you try to perform Pixel Mapping or Sensor Cleaning, or to update the firmware if the battery level is insufficient. Install a fully charged battery.
Not enough battery power remaining to clean sensor	
Not enough battery power remaining to update the firmware	
Unable to update firmware. There is a problem with the firmware update file	Unable to update the firmware. The update file is damaged. Try downloading the update file again.
Image folder cannot be created	The maximum folder number (999) is being used, and no more images can be saved. Insert a new memory card or format the card.
Unable to store image	The image could not be saved because of a memory card error.
The operation could not be completed correctly	The camera was unable to adjust the manual white balance. Try the operation again.
No more images can be selected	You are trying to select more than the maximum number of images for the following functions. <ul style="list-style-type: none"> • Select & Delete • RAW Development • Protect
No image can be processed	There are no images that can be processed using the Digital Filter or RAW Development function.
This image cannot be processed	Appears when you try to perform Resize, Cropping, Digital Filter, Movie Edit, RAW Development, or Save as Manual WB for images captured with other cameras, or when you try to perform Resize or Cropping for minimum file size images.

Error messages	Description
This function is not available in the current mode	You are trying to set a function that is not available for the capture mode that is set.
The camera will turn off to prevent damage from overheating	The camera will turn off because its internal temperature is too high. Leave the camera turned off until it has had time to cool down before turning on the camera again.
Shutter release is disabled. Ensure the zooming index on the lens is set to a position that permits shutter release	Pictures cannot be taken when a retractable lens is attached and is not extended.

Main Specifications

Model Description

Type	TTL autofocus, auto-exposure SLR digital camera with a built-in retractable P-TTL flash
Lens Mount	PENTAX KAF2 bayonet mount (AF coupler, lens information contacts, K-mount with power contacts)
Compatible Lenses	KAF3, KAF2 (power zoom not compatible), KAF, KA mount lenses

Image Capture Unit

Image Sensor	Primary color filter, CMOS, Size: 23.5 × 15.6 (mm)
Effective Pixels	Approx. 20.12 megapixels
Total Pixels	Approx. 20.42 megapixels
Dust Removal	SP coating and CMOS sensor vibration
Sensitivity	ISO AUTO/100 to 51200 (EV steps can be set to 1 EV, 1/2 EV, or 1/3 EV)
Image Stabilizer	Sensor-shift Shake Reduction
AA Filter Simulator	Moiré reduction using SR unit: OFF/Type1/Type2/Bracketing

File Formats

Recording Formats	RAW (PEF/DNG), JPEG (Exif 2.30), DCF 2.0 compliant
Recorded Pixels	JPEG: [L] (20M: 5472×3648), [M] (12M: 4224×2816), [S] (6M: 3072×2048), [XS] (2M: 1920×1280) RAW: [L] (20M: 5472×3648)
Quality Level	RAW (12bit): PEF, DNG JPEG: ★★★ (Best), ★★ (Better), ★ (Good) RAW + JPEG simultaneously recordable
Color Space	sRGB, AdobeRGB
Storage Media	SD/SDHC*/SDXC* memory card (*UHS-I compatible)

Storage Folder	Folder Name: Date (100_1018, 101_1019...) or a user-assigned name (default: PENTX)
Storage File	File Name: user-assigned name (default: IMG*****) File No.: Sequential Numbering, Reset

Viewfinder

Type	Pentaprism Finder
Coverage (FOV)	Approx. 100%
Magnification	Approx. 0.95× (50mm F1.4 at infinity)
Eye-Relief Length	Approx. 20.5 mm (from the view window), Approx. 22.3 mm (from the center of lens)
Diopter Adjustment	Approx. -2.5 to +1.5 m ⁻¹
Focusing Screen	Interchangeable Natural-Bright-Matte III focusing screen

Live View

Type	TTL method using the CMOS image sensor
Focusing System	Contrast detection (Face Detection, Tracking, Multiple AF Points, Select, Spot) Focus Peaking: ON/OFF
Display	Field of view: approx. 100%, Electronic Level Display, Magnified view (up to 10×), Grid Display (4 × 4 Grid, Golden Section, Scale), Histogram, Highlight Alert

LCD Monitor

Type	Vari-angle TFT color LCD monitor featuring an air-gapless structure with a tempered-glass front panel
Size	3.0 inches (3:2)
Dots	Approx. 921K dots
Adjustment	Brightness, saturation and colors adjustable

White Balance

Type	Method using a combination of the CMOS image sensor and the light source detection sensor
Preset Modes	Auto White Balance, Multi Auto White Balance, Daylight, Shade, Cloudy, Fluorescent Light (D : Daylight Color, N : Daylight White, W : Cool White, L : Warm White), Tungsten Light, Flash, CTE , Manual White Balance, Color Temperature, Copying the white balance settings of a captured image
Fine Adjustment	Adjustable ± 7 steps on A-B axis and G-M axis

Autofocus System

Type	TTL: phase-matching autofocus
Focus Sensor	SAFOX X, 11 points (9 cross type focus points in the center)
Brightness Range	EV -3 to 18 (ISO100, at normal temperature)
AF Modes	Single AF (A.F.S.), Continuous AF (A.F.C.), Auto select AF (A.F.A.)
Focus Point Selection Modes	Auto (11 AF Points), Auto (5 AF Points), Select, Expanded Area AF, Spot
AF Assist Light	Dedicated LED AF assist light

Exposure Control

Type	TTL open-aperture 77 segment metering Metering modes: Multi-segment, Center-weighted, Spot
Metering Range	EV 0 to 22 (ISO100 at 50mm F1.4)
Capture Modes	Auto Picture modes: Standard, Portrait, Landscape, Macro, Moving Object, Night Scene Portrait, Sunset, Blue Sky, Forest Scene Modes: Portrait, Landscape, Macro, Moving Object, Night Scene Portrait, Sunset, Blue Sky, Forest, Night Scene, Night Scene HDR (JPEG only), Night Snap, Food, Pet, Kids, Surf & Snow, Backlight Silhouette, Candlelight, Stage Lighting, Museum Advanced HDR mode (JPEG only): exposure bracket value is selectable from ± 1 , ± 2 or ± 3 EV Exposure modes: Program, Sensitivity Priority, Shutter Priority, Aperture Priority, Shutter & Aperture Priority, Manual, Bulb

EV Compensation	± 5 EV (1/3 EV steps or 1/2 EV steps can be selected)
AE Lock	Can be assigned to AF/AE-L from [Button Customization].

Shutter

Type	Electronically controlled vertical-run focal plane shutter
Shutter Speed	Auto: 1/6000 to 30 seconds, Manual: 1/6000 to 30 seconds (1/3 EV steps or 1/2 EV steps), Bulb

Drive Modes

Mode Selection	[Still picture] Single frame, Continuous (H, L), Self-timer (12 sec., 2 sec., continuous), Remote Control (immediately, 3 sec., continuous), Bracketing ^{*1} , Multi-exposure ^{*2} , Interval Shooting ^{*1} , Interval Composite ^{*1} [Movie] Remote Control, Interval Movie Record ^{*1} , Star Stream ^{*1} ^{*1} Available with Self-timer or Remote Control ^{*2} Available with Continuous Shooting, Self-timer, or Remote Control
Continuous Shooting	Max. approx. 5.5 fps, JPEG ([L]: ★★★ at Continuous H): 30 frames, RAW: 9 frames, RAW+: 6 frames Max. approx. 3.0 fps, JPEG ([L]: ★★★ at Continuous L): 100 frames, RAW: 14 frames, RAW+: 8 frames • When the sensitivity is set to ISO100.
Multi-exposure	Composite Mode: Additive, Average, Bright Number of Shots: 2 to 2000 times

Interval Shooting	[Interval Shooting] Interval: 2 sec. to 24 hr., Standby Interval: minimum time or 1 sec. to 24 hr., Number of Shots: 2 to 2000 times, Start Interval: Now, Set Time [Interval Composite] Interval: 2 sec. to 24hr., Standby Interval: minimum time or 1 sec. to 24 hr., Number of Shots: 2 to 2000 times, Start Interval: Now, Set Time, Composite Mode: Additive, Average, Bright, Save Process: On, Off [Interval Movie] Recorded Pixels: [4K], [FullHD], [HD], Interval: 2 sec. to 24 hr., Standby Interval: minimum time or 1 sec. to 24 hr., Number of Shots: 8 to 2000 times ([4K]: 8 to 500 times), Start Interval: Now, Set Time [Star Stream] Recorded Pixels: [4K], [FullHD], [HD], Standby Interval: minimum time or 1 sec. to 24 hr., Number of Shots: 8 to 2000 times ([4K]: 8 to 500 times), Start Interval: Now, Set Time, Fade-out: Off, Low, Medium, High
-------------------	---

Flash

Built-in Flash	Built-in retractable P-TTL pop-up flash Guide number: approx. 12 (ISO100/m) Angle of view coverage: equivalent to 28mm lens in 35 mm format
Flash Modes	Auto Flash Discharge (Auto Picture, Scene Mode), Auto Flash + Red-eye Reduction (Auto Picture, Scene Mode), Flash On, Flash On + Red-eye Reduction, Slow-speed Sync, Slow-speed Sync + Red-eye, Trailing Curtain Sync, Manual Flash Discharge (FULL to 1/128 power)
Sync Speed	1/180 sec.
Flash Exposure Compensation	-2.0 to +1.0 EV
External Flash	P-TTL, Leading Curtain Sync, Trailing Curtain Sync, Contrast-control-sync, High-speed Sync, Wireless Sync • Available with 2 dedicated external flashes

Capture Functions

Custom Image	Bright, Natural, Portrait, Landscape, Vibrant, Radiant, Muted, Bleach Bypass, Reversal Film, Monochrome, Cross Processing
Cross Processing	Random, Preset 1-3, Favorite 1-3
Digital Filter	Extract Color, Replace Color, Toy Camera, Retro, High Contrast, Shading, Invert Color, Unicolor Bold, Bold Monochrome
HDR Capture	Auto, Type1, Type2, Type3 Bracket Value adjustable Auto Align: On, Off
Clarity Enhancement	On, Off
Lens Correction	Distortion Correction, Peripheral Illumination Correction, Lateral Chromatic Aberration Correction, Diffraction Correction
D-Range Settings	Highlight Correction, Shadow Correction
Noise Reduction	Slow Shutter Speed NR, High-ISO NR
Electronic Level	Displayed in viewfinder (horizontal direction only); displayed on LCD monitor (horizontal direction and vertical direction)
Horizon Correction	SR On: corrects up to 1 degree, SR Off: corrects up to 1.5 degrees

Movie

File Format	MPEG-4 AVC/H.264 (MOV) • Motion JPEG (AVI) for Interval Movie Record and Star Stream
Recorded Pixels Framerate	[FullHD] (1920×1080, 30p/25p/24p) [HD] (1280×720, 60p/50p)
Sound	Built-in stereo microphone, external microphone (stereo recording compatible) Recording Sound Level adjustable (sound level is displayed on the monitor)
Recording Time	Up to 4 GB or 25 minutes; automatically stops recording if the internal temperature of the camera becomes high.

Custom Image	Bright, Natural, Portrait, Landscape, Vibrant, Radiant, Muted, Bleach Bypass, Reversal Film, Monochrome, Cross Processing
Cross Processing	Random, Preset 1-3, Favorite 1-3
Digital Filter	Extract Color, Replace Color, Toy Camera, Retro, High Contrast, Shading, Invert Color, Unicolor Bold, Bold Monochrome
HDR Capture • Available only for Interval Movie Record	Auto, Type1, Type2, Type3 Bracket Value adjustable
Clarity Enhancement • Available only for Interval Movie Record	On, Off

Playback Functions

Playback View	Single frame, Multi-image display (6, 12, 20, 35, and 80 thumbnails), Image magnification (Up to 16 \times , quick zoom), Rotated image display, Histogram (Y histogram, RGB histogram), Highlight Alert, Detailed Information Display, Copyright Information (Photographer, Copyright Holder), GPS information (Latitude, Longitude, Altitude, Coordinated Universal Time (UTC)), Direction, Folder Display, Calendar Filmstrip Display, Slideshow
Delete	Single image, all images, select & delete, folder, Instant Review image
Digital Filter	Base Parameter Adj, Extract Color, Replace Color, Toy Camera, Retro, High Contrast, Shading, Invert Color, Unicolor Bold, Bold Monochrome, Tone Expansion, Sketch, Water Color, Pastel, Posterization, Miniature, Soft, Starburst, Fish-eye, Slim, Monochrome

RAW Development	Development options: Select single image, Select multiple images, Select a folder Development parameters: File Format (JPEG), Aspect Ratio, JPEG Recorded Pixels, JPEG Quality, Color Space, Distortion Correction, Peripheral Illumin. Corr., Lat-Chromatic-Ab Adj, Diffraction Correction, Color Fringe Correction, White Balance, Custom Image, Digital Filter, Clarity Enhancement, Sensitivity, High-ISO NR, Shadow Correction
Editing Features	Image Rotation, Color Moiré Correction, Resize, Cropping (aspect ratio can be changed and tilt correction is available), Movie Edit (dividing a movie file and deleting unwanted segments), Capturing a JPEG still picture from a movie, Save RAW Data

Customization

USER Mode	Up to 2 settings can be saved.
Custom Functions	28 items
Mode Memory	12 items
E-Dial Programming	E-dials (front/rear): customizable to each exposure mode
Button Customization	RAW/F button: One Push File Format, Bracketing, Optical Preview, Digital Preview, Shake Reduction, AF Active Area AF/AE button: Enable AF1, Enable AF2, Cancel AF, AE Lock (can be customized for taking still pictures and for recording movies separately) Self-portrait shutter button: On, Off
AF Customization	AF.S Setting: Focus-priority, Release-priority 1st Frame Action in AF.C: Release-priority, Auto, Focus-priority Action in AF.C Continuous: Focus-priority, Auto, FPS-priority Hold AF Status: Off, Low, Medium, High AF in Interval Shooting: Locks focus at 1st exposure, Adjusts focus for each shot
Text Size	Standard, Large
World Time	World Time settings for 75 cities (28 time zones)
AF Fine Adjustment	± 10 steps, adjustment for all lenses or individual lenses (up to 20 values can be saved)

Copyright Information	Names of "Photographer" and "Copyright Holder" are embedded to the image file. A revision history can be checked using the provided software.
-----------------------	---

Power Supply

Battery Type	Rechargeable Lithium-ion Battery D-LI109
AC Adapter	AC Adapter Kit K-AC128 (optional)
Battery Life	<p>Number of recordable images: (with 50% flash usage): approx. 410 images, (without flash usage): approx. 480 images Playback time: approx. 270 minutes</p> <ul style="list-style-type: none"> Tested in compliance with CIPA standard using a fully charged lithium-ion battery at a temperature of 23°C. Actual results may vary depending on the shooting conditions/circumstances.

Interfaces

Connection Port	USB 2.0 (micro B), HDMI output terminal (Type D), stereo microphone input terminal
USB Connection	MSC/PTP

Wireless LAN

Standards	IEEE 802.11b/g/n (standard wireless LAN protocol)
Frequency (Center Frequency)	2412 to 2462 MHz (channels: Ch 1 to Ch 11)
Security	Authentication: WPA2 Encryption: AES

NFC

Standards	ISO/IEC14443 TypeA, ISO/IEC14443 TypeB, JIS X 6319-4 (automatically selected)
Operating Frequency	13.56 MHz

Dimensions and Weight

Dimensions	Approx. 122.5 mm (W) × 91 mm (H) × 72.5 mm (D) (excluding protrusions)
Weight	Approx. 678 g (Including dedicated battery and SD Memory Card) Approx. 618 g (body only)

Included Accessories

Package Contents	Strap O-ST132, Rechargeable Lithium-ion Battery D-LI109, Battery Charger D-BC109, AC plug cord, Software (CD-ROM) S-SW156, Start Guide <Mounted to the camera> Eyecup Fr, Hot shoe cover F _K , Body mount cover
Software	Digital Camera Utility 5

Optional Accessories

GPS Unit	O-GPS1: GPS information (Latitude, Longitude, Altitude, Coordinated Universal Time (UTC)), Direction, Electronic Compass, ASTROTRACER
----------	---

Approximate Image Storage Capacity and Playback Time

(When using the fully charged battery)

Battery	Temperature	Normal Shooting	Flash Photography		Playback Time
			50% Use	100% Use	
D-LI109	23°C	480	410	360	270 minutes

- The image storage capacity (normal recording and flash use 50%) is based on measuring conditions in accordance with CIPA standards, while other data is based on our measuring conditions. Some deviation from the above figures may occur in actual use depending on the selected capture mode and shooting conditions.

Approximate Image Storage Capacity by Size

(When using a 2 GB memory card)

Recorded Pixels	JPEG Quality			PEF	DNG
	★★★	★★	★		
L 20M	134	304	596	59	59
M 12M	224	503	975	–	–
S 6M	418	917	1707	–	–
XS 2M	1024	2119	3615	–	–

- The number of storable images may vary depending on the subject, shooting conditions, selected capture mode and memory card, etc.

List of World Time Cities

The following cities can be set as Hometown and Destination.

Region	City
North America	Honolulu, Anchorage, Vancouver, San Francisco, Los Angeles, Calgary, Denver, Chicago, Miami, Toronto, New York, Halifax
Central and South America	Mexico City, Lima, Santiago, Caracas, Buenos Aires, Sao Paulo, Rio de Janeiro
Europe	Lisbon, Madrid, London, Paris, Amsterdam, Milan, Rome, Copenhagen, Berlin, Prague, Stockholm, Budapest, Warsaw, Athens, Helsinki, Moscow
Africa/ West Asia	Dakar, Algiers, Johannesburg, Istanbul, Cairo, Jerusalem, Nairobi, Jeddah, Tehran, Dubai, Karachi, Kabul, Male, Delhi, Colombo, Kathmandu, Dacca
East Asia	Yangon, Bangkok, Kuala Lumpur, Vientiane, Singapore, Phnom Penh, Ho chi Minh, Jakarta, Hong Kong, Beijing, Shanghai, Manila, Taipei, Seoul, Tokyo, Guam
Oceania	Perth, Adelaide, Sydney, Noumea, Wellington, Auckland, Pago Pago

Operating Environment for USB Connection and Provided Software

With the provided software "Digital Camera Utility 5", you can develop RAW files, make color adjustments, or check shooting information on a computer. Install the software from the provided CD-ROM (S-SW156).

We recommend the following system requirements to connect the camera to a computer and to use the software.

Windows

OS	Windows 8.1 (32-bit, 64-bit), Windows 8 (32-bit, 64-bit), Windows 7 (32-bit, 64-bit), or Windows Vista (32-bit, 64-bit)
CPU	Intel Core 2 Duo or higher
RAM	2 GB or more
HDD	For installing and starting up the program: 100 MB or more of available space For saving image files: Approx. 10 MB/file (JPEG), Approx. 20 MB/file (RAW)
Monitor	1280×1024 dots, 24-bit full color or higher

























Macintosh

OS	OS X 10.10, 10.9, 10.8, or 10.7
CPU	Intel Core 2 Duo or higher
RAM	2 GB or more
HDD	For installing and starting up the program: 100 MB or more of available space For saving image files: Approx. 10 MB/file (JPEG), Approx. 20 MB/file (RAW)
Monitor	1280×1024 dots, 24-bit full color or higher

● Memo

- QuickTime is required to play back movies transferred to a computer with an OS other than Windows 8 and Windows 8.1. (A computer with Windows 8 or Windows 8.1 can play back movies with a pre-installed player software.)
You can download it from the following site:
<http://www.apple.com/quicktime/download/>

Symbols

 menu.....	21
 menu.....	25
 menu.....	25
 menu.....	26
 menu.....	28
 mode.....	49
 Portrait.....	45
 Landscape.....	45
 Macro.....	45
 Moving Object.....	45
 Night Scene Portrait ..	45
 Sunset.....	45
 Blue Sky.....	45
 Forest.....	45
 Night Scene.....	46
 Night Scene HDR.....	46
 Night Snap.....	46
 Food.....	46
 Pet.....	46
 Kids.....	46
 Surf & Snow.....	46
 Backlight Silhouette...	46
 Candlelight.....	46
 Stage Lighting.....	46
 Museum.....	46

Numerics

1st Frame Action in AF.C	
.....	55

A

AA Filter Simulator.....	76
AC adapter.....	33
Action in AF.C Continuous	
.....	55
Advanced HDR mode.....	46
AE Lock.....	49, 101
AE Metering.....	52
AE-L with AF Locked.....	28
AF	54
AF area.....	57
AF Assist Light.....	55
AF assist light.....	7
AF coupler.....	7
AF Fine Adjustment.....	58
AF frame.....	40, 41
AF in Interval Shooting....	65
AF Mode.....	55, 57
AF point.....	56
AF with Remote Control ..	61
AFA	55
AFC	55
AFS	55
AF.S Setting.....	55
AF/AE-L Button.....	101
A-HDR mode.....	46
Anti-aliasing filter.....	76
Aperture Priority Automatic	
Exposure.....	47
Aperture value.....	47
Aspect Ratio.....	83, 87

ASTROTRACER.....	118
Auto (AF Active Area).....	56
Auto EV Compensation....	28
Auto Flash Discharge.....	53
Auto Image Rotation.....	80
AUTO mode.....	39
Auto Picture mode.....	39
Auto Power Off.....	36
Autofocus.....	54
AV device.....	81
Av mode.....	47
AWB	68
AWB in Tungsten Light....	69

B

B mode.....	47
Backlight Silhouette (SCN)	
.....	46
Base Parameter Adj (Digital	
Filter).....	84
Battery.....	31
Bleach Bypass (Custom	
Image).....	71
Blue Sky (SCN).....	45
Bold Monochrome (Digital	
Filter).....	73, 84
Bracketing.....	62
Bracketing Order.....	62
Bright (Custom Image)....	71
Brightness adjustment.....	74
Brightness histogram.....	15
Built-in flash.....	53
Bulb (B) Mode Options....	28
Bulb Exposure.....	47
Button.....	8
Button Customization....	100

C

Calendar Filmstrip Display	
.....	79
Cancel AF.....	101
Candlelight (SCN).....	46
Capture mode.....	45
Card.....	34
Card access lamp.....	7
Catch-in Focus.....	29
Center-weighted metering	
.....	52
Certification Marks... 27,	138
Changing the image size	
.....	83
Charging the battery.....	31
City names.....	37, 128
Clarity Enhancement.....	76
Cleaning.....	120
Cloudy (White Balance)...	68
Color Fringe Correction...	87
Color Moiré Correction....	84
Color Space.....	29, 108
Color Temperature.....	70
Color Temperature Steps	
.....	70

Communication device	91	Developing RAW images	87	Extract Color (Digital Filter)	73, 84	G	GPS Time Sync	117
Communication Info	89	Dial	8				GPS unit	117
Computer	82	Dial indicator	39	F			Grid Display	22
Connection cable cover ...	33	Diffraction Correction	75	Face Detection (Contrast AF)	57		Guide Display	26, 39
Continuous mode (AF Mode)	55	Digital Camera Utility 5 ..	129	File Format	44		Guide number	54
Continuous playback	80	Digital Filter	73, 84	File Name	108	H		
Continuous Shooting	60	Digital Preview	101	File No.	108		HDMI Out	81
Contrast AF	57	Dioptr adjustment lever	16	Filter	73, 84		HDMI terminal	81
Contrast detection AF	54	Direct keys	18	Fine Sharpness (Custom Image)	71		HDR Capture	46, 74
Control panel	12, 18	Display Color	26, 38	Firmware	27		High Contrast (Digital Filter)	73, 84
Copyright Holder	109	Distortion Correction	75	Firmware Info/Options	27		High-ISO NR	52
Copyright Information	109	DNG	44	Fish-eye (Digital Filter) ...	84		Highlight Alert	22, 23, 25
Correcting images	74	D-Range Settings	74	Flash	53, 116		Highlight Correction	74
Create New Folder	107	Drive Mode	59	Flash (White Balance)	68		High-speed Sync flash... ..	117
Cropping	83	DST (daylight saving time)	37, 105	Flash compensation	53		Histogram Display	15, 22, 23
Cross Processing (Custom Image)	71	Dust Removal	119	Flash On	53		Hold AF Status	55
CTE	68	Dynamic range	74	Flicker Reduction	27		Hometown	105
Custom Image	71	E		Fluorescent (White Balance)	68		Horizon Correction	22
Custom Setting menus	28	E-dial	100	Focus indicator	40		Hot shoe	7
Customization	100	Editing images	83	Focus Method	54	I		
D		Electronic Compass	13, 117	Focus mode switch	39, 54		Image Capture Settings... ..	44
Date Adjustment	26, 37	Electronic Level	13, 17	Focus Peaking	57		Image finishing tone	71
Daylight (White Balance)	68	Error messages	121	Folder display	79		Image plane indicator	7
DC coupler	33	EV Compensation	48	Folder Name	106		Image storage capacity	128
Delete	43	EV Steps	48	Food (SCN)	46		Image Sync	93
Delete All Images	25	Expanded Area AF (AF Active Area)	56	Format	38		Indicator Lamps	27
Depth of field	48	Exposure Bracketing	62	Four-way controller	10		Initial settings	36
Destination	105	Exposure modes	47, 104	Framerate	44		Initializing a memory card	38
Detailed Information Display	14	External flash	116	Function restrictions	110			

- Input Focal Length..... 116
 Instant Review 23, 40
 Interval Composite 65
 Interval Movie Record 66
 Interval Shooting 64
 Interval Shooting Options
 65
 Invert Color (Digital Filter)
 73, 84
 ISO sensitivity..... 51
- J**
 JPEG 44
- K**
 Kelvin..... 70
 Kids (**SCN**)..... 46
- L**
 Lamp 10
 Landscape (**SCN**) 45
 Landscape (Custom Image)
 71
 Language/言語 26, 36
 Language setting 37
 Lat-Chromatic-Ab Adj 75
 LCD Display 26, 38
 LCD Display Settings 26
 Lens..... 30, 113
 Lens Correction 75
 Lens focal length 116
 Lens information contacts
 7
 Lens mount index 30
 Lens unlock button 31
- Lens with aperture ring.. 115
 Link AE and AF Point 52
 Live View 11, 22
- M**
M mode 47
 Macintosh 129
 Macro (**SCN**)..... 45
 Magnifying images 43
 Manual Exposure 47
 Manual Flash Discharge.. 53
 Manual focus 54
 Manual White Balance 70
 Memory 105
 Memory card 34
 Menu 19
 Meter Operating Time 28
- MF** 54
 Microphone..... 7, 50
 Microphone terminal..... 50
 Miniature (Digital Filter) ... 84
 Mired 70
 Mirror 7
 Mirror Up 120
 Mode dial 39
 Moiré reduction..... 76
 Monitor 10, 35
 Monochrome (Custom
 Image) 71
 Monochrome (Digital Filter)
 84
 Motion JPEG 66
 Mount type..... 113
 Movie 49
 Movie Edit..... 86
- Movie menu 25
 Movie SR 25
 Moving Object (**SCN**)..... 45
 MSC 119
 Multi Auto White Balance
 (White Balance)..... 68
 Multi-exposure 63
 Multi-image display..... 78
 Multiple AF Points (Contrast
 AF)..... 57
 Multi-segment metering... 52
 Museum (**SCN**) 46
 Muted (Custom Image).... 71
- N**
 Natural (Custom Image) .. 71
 NFC 91
 NFC mark 7, 90
 Night Scene (**SCN**) 46
 Night Scene HDR (**SCN**)
 46
 Night Scene Portrait (**SCN**)
 45
 Night Snap (**SCN**)..... 46
 Noise Reduction 48, 52
- O**
 One Push File Format ... 102
 One-Push Bracketing 62
 Operating environment.. 129
 Optical Preview 101
 Other Indicator Lamps..... 27
- P**
P mode 47
- Pastel (Digital Filter) 84
 PEF..... 44
 Peripheral Illumin. Corr.... 75
 Pet (**SCN**) 46
 Photographer 109
 Pixel Mapping 119
 Playback Info Display
 selection screen..... 14
 Playback menu 25
 Playback mode 42
 Playback mode palette 77
 Portrait (**SCN**) 45
 Portrait (Custom Image) .. 71
 Posterization (Digital Filter)
 84
 Power 36
 Preview 48
 Processing images 83
 Program Automatic Exposure
 47
 Protect 106
 Protect All Images 25
 Provided software..... 129
 PTP..... 119
- Q**
 Quality 44
 Quick Zoom 25
 QuickTime 129
- R**
 Radiant (Custom Image)
 71
 RAW 44
 RAW Development 87

RAW/Fx Button.....	101	Selecting the range of images	78	Sketch (Digital Filter)	84	Tone Expansion (Digital Filter)	84
Rec. Mode menus	21	Self-portrait Shutter Button	41, 90, 101	Slideshow	80	Toy Camera (Digital Filter)	73, 84
Recordable time	49	Self-timer shooting	60	Slim (Digital Filter)	84	Tracking (Contrast AF)	57
Recorded Pixels	44	Sensitivity	51	Slow Shutter Speed NR ..	48	Trailing Curtain Sync	53
Recording Sound Level ...	50	Sensitivity Priority Automatic Exposure	47	Slow-speed Sync	53	TTL phase-matching autofocus	54
Red-eye Reduction.....	53	Sensitivity Steps	51	Soft (Digital Filter).....	84	Tungsten (White Balance)	68
Release While Charging..	53	Sensor Cleaning	120	Software	129	TV	81
Remote control receiver ...	7	Sequential Numbering... ..	108	Sound	49	Tv mode.....	47
Remote Control shooting	61	Set-up menus	26	Sound Effects	26	U	
Remote Shooting.....	91	Shade (White Balance) ...	68	Speaker	7	Unicolor Bold (Digital Filter)	73, 84
Replace Color (Digital Filter)	73, 84	Shading (Digital Filter)	73, 84	Specifications	123	Updating firmware	27
Reset	27, 29	Shadow Correction	74	Spot (AF Active Area).....	56	USB Connection	82, 119, 129
Resize	83	Shake Reduction	22	Spot (Contrast AF)	57	USB terminal	82
Retractable lens	40	Sharpness (Custom Image)	71	Spot metering	52	USER mode.....	103
Retro (Digital Filter) ...	73, 84	Shooting	39	Stage Lighting (SCN).....	46	User registration	6
Reversal Film (Custom Image)	71	Shooting celestial bodies	118	Standby mode	10	Using aperture ring	115
RGB histogram	15	Shooting Info Display	13	Star Stream	67	V	
Rotating images	80	Shooting with Live View ..	41	Starburst (Digital Filter)....	84	Version update	27
Rotation Direction	100	Shooting with viewfinder..	39	Status Screen	11	Vibrant (Custom Image) ..	71
S		Shutter & Aperture Priority Automatic Exposure	47	Still picture	45	Viewfinder.....	16
SCN mode	45	Shutter Priority Automatic Exposure	47	Strap	30	Volume label.....	38
Save as Manual WB	70	Shutter speed	47	Strap lug	30	W	
Save Cross Processing ...	72	Single Frame Shooting... ..	59	Sunset (SCN).....	45	WARRANTY POLICY.....	141
Save Menu Location.....	20	Single image display	14, 42	Superimpose AF Area	16	Water Color (Digital Filter)	84
Save RAW Data ..	23, 40, 43	Single mode (AF Mode) ..	55	Surf & Snow (SCN).....	46	WB Adjustable Range	69
Save Rotation Info.....	80	Sv mode		Switch	8		
Scene modes	45	Switch	8	T			
SD Memory Card.....	34	Taking a self-portrait.....	41	TAV mode.....	47		
Select (AF Active Area) ...	56	Text input.....	103	Text input.....	103		
Select (Contrast AF).....	57	Text Size	26, 37	Text Size	26, 37		
Select & Delete.....	78	Thumbnail display	43, 78	Thumbnail display	43, 78		
		Time Setting	105	Time Setting	105		

WB When Using Flash	69
White Balance	68
Wi-Fi	89
Windows	129
Wireless LAN.....	89
World Time	105

For Using Your Camera Safely

We have paid close attention to the safety of this camera. When using this camera, we request your special attention regarding items marked with the following symbols.



Warning

This symbol indicates that ignoring this item could cause serious personal injuries.



Caution

This symbol indicates that ignoring this item could cause minor or medium personal injuries, or loss of property.

About the Camera



Warning

- Do not disassemble or modify the camera. High voltage areas are present inside the camera, with the risk of electric shock.
- If the camera interior is exposed due to dropping or otherwise damaging the camera, never touch the exposed portion. There is a risk of electric shock.
- Do not aim the camera at the sun or other strong light sources when taking pictures or leave the camera sitting in direct sunlight with a lens cap off. Doing so may cause the camera to malfunction or cause a fire.
- Do not look at the sun or other strong light sources through a lens. Doing so may lead to a loss of eyesight or cause vision to be impaired.
- If any irregularities occur during use, such as smoke or a strange odor, stop use immediately, remove the battery or the AC adapter, and contact your nearest service center. Continued use can cause a fire or electrical shock.



Caution

- Do not place your finger over the flash when discharging the flash. You may burn yourself.
- Do not cover the flash with clothing when discharging the flash. Discoloration may occur.
- Some portions of the camera heat up during use. There is a risk of low temperature burns when holding such portions for long periods.

- Should the monitor be damaged, be careful of glass fragments. Also, be careful not to allow the liquid crystal to get on your skin or in your eyes or mouth.
- Depending on your individual factors or physical condition, the use of the camera may cause itching, rashes or blisters. In case of any abnormality, stop using the camera and get medical attention immediately.

About the Battery Charger and AC Adapter



Warning

- Always use the battery charger and AC adapter exclusively developed for this camera, with the specified power and voltage. Using a battery charger or AC adapter not exclusive to this camera, or using the exclusive battery charger or AC adapter with an unspecified power or voltage can cause a fire, electric shock, or camera breakdown. The specified voltage is 100 - 240V AC.
- Do not disassemble or modify the product. This can cause a fire or electrical shock.
- If the generation of smoke or strange odor from the product or other abnormality occurs, immediately discontinue using and consult your nearest service center. Continued use can cause a fire or electrical shock.
- If water should happen to get inside the product, consult your nearest service center. Continued use can cause a fire or electrical shock.
- If you see a lightning flash or hear thunder during use of the battery charger or AC adapter, unplug the power plug and discontinue using. Continued use can cause damage to the product, fire or electrical shock.
- Wipe off the power plug if it should become covered with dust. Accumulated dust may cause a fire.
- To reduce the risk of hazards, use only CSA/UL certified power supply cord set, cord is Type SPT-2 or heavier, minimum NO.18 AWG copper, one end with a molded-on male attachment plug cap (with a specified NEMA configuration), and the other is provided with a molded-on female connector body (with a specified IEC nonindustrial type configuration) or the equivalent.



Caution

- Do not place or drop heavy objects on or forcefully bend the AC plug cord. Doing so may damage the cord. Should the AC plug cord be damaged, consult your nearest service center.

- Do not touch or short-circuit the terminal area of the AC plug cord while the cord is plugged in.
- Do not handle the power plug with wet hands. This can cause an electric shock.
- Do not drop the product, or subject it to violent impact. This can cause the product to breakdown.
- Do not use the battery charger D-BC109 to charge batteries other than the rechargeable lithium-ion battery D-LI109. Attempting to charge other types of batteries may cause an explosion or heating, or may damage the battery charger.

About the Rechargeable Lithium-ion Battery

Warning

- If any leakage from the battery should come in contact with your eyes, do not rub them. Flush your eyes with clean water and get medical attention immediately.

Caution

- Only use the specified battery with this camera. Use of other batteries may cause an explosion or fire.
- Do not disassemble the battery. Disassembling the battery may cause an explosion or leakage.
- Remove the battery from the camera immediately if it becomes hot or begins to smoke. Be careful not to burn yourself during removal.
- Keep wires, hairpins, and other metal objects away from the + and - contacts of the battery.
- Do not short the battery or dispose of the battery in fire. This can cause an explosion or fire.
- If any leakage from the battery should come in contact with skin or clothing, it may cause irritation to the skin. Wash the affected areas thoroughly with water.
- Precautions for D-LI109 Battery Usage:
 - USE SPECIFIED CHARGER ONLY.
 - DO NOT INCINERATE.
 - DO NOT DISASSEMBLE.
 - DO NOT SHORT CIRCUIT.
 - DO NOT EXPOSE TO HIGH TEMP. (140°F / 60°C)

Keep the Camera and its Accessories out of the Reach of Small Children

Warning

- Do not place the camera and its accessories within the reach of small children.
 1. If the product falls or is operated accidentally, it may cause serious personal injuries.
 2. Wrapping the strap around a neck may cause suffocation.
 3. To avoid the risk of a small accessory such as the battery or memory cards from being swallowed by mistake, keep them out of the reach of small children. Seek medical attention immediately if an accessory is accidentally swallowed.

Care to be Taken During Handling

Before Using Your Camera

- When the camera has not been used for a long time, confirm that it is still working properly, particularly prior to taking important pictures (such as at a wedding or when traveling). Contents of the recording cannot be guaranteed if recording, playback or transferring your data to a computer, etc. is not possible due to a malfunction of your camera or recording media (memory cards), etc.

About the Battery and Charger

- To keep the battery in optimum condition, avoid storing it in a fully charged state or in high temperatures.
- If the battery is left inserted and the camera is not used for a long time, the battery will over-discharge and shorten the battery's life.
- Charging the battery a day before use or on the day of use is recommended.
- The AC plug cord provided with this camera is developed exclusively for the battery charger D-BC109. Do not use it with other devices.

Precautions on Carrying and Using Your Camera

- Do not subject the camera to high temperatures or high humidity. Do not leave the camera in a vehicle, as the temperature can get very high.
- Do not subject the camera to strong vibrations, shocks, or pressure. Use a cushion to protect the camera from vibrations of motorcycles, automobiles, or ships.
- The temperature range for camera use is -10°C to 40°C (14°F to 104°F).
- The monitor may appear black at high temperatures, but will return to normal at normal temperatures.
- The monitor may respond more slowly at low temperatures. This is due to liquid crystal properties, and is not a malfunction.
- Sudden temperature changes will cause condensation on the inside and outside of the camera. Place the camera in your bag or a plastic bag, and remove it after temperatures of the camera and surroundings are equalized.

- Avoid contact with garbage, mud, sand, dust, water, toxic gases, or salt. These could cause the camera to breakdown. Wipe the camera to dry off any rain or water drops.
- Do not press on the monitor with excessive force. This could cause it to break or malfunction.
- Be careful not to overtighten the screw in the tripod socket when using a tripod.

Cleaning Your Camera

- Do not clean the camera with organic solvents such as thinner, alcohol, and benzine.
- Use a lens brush to remove dust accumulated on the lens. Never use a spray blower for cleaning as it may damage the lens.
- Please contact your nearest service center for professional cleaning of the CMOS sensor. (This will involve a fee.)
- Periodic inspections are recommended every one to two years to maintain high performance.

Storing Your Camera

- Do not store the camera with preservatives or chemicals. Storage in high temperatures and high humidity can cause mold to grow on the camera. Remove the camera from its case and store it in a dry and well-ventilated place.
- Avoid using or storing the camera where it may be exposed to static electricity or electrical interference.
- Avoid using or storing the camera in direct sunlight or in locations where it may be exposed to rapid changes in temperature or to condensation.

About SD Memory Cards

- The SD Memory Card is equipped with a write-protect switch. Setting the switch to LOCK prevents new data from being recorded on the card, the stored data from being deleted, and the card from being formatted by the camera or computer.
- The SD Memory Card may be hot when removing the card immediately after using the camera.
- Do not remove the SD Memory Card or turn off the power while the card is being accessed. This may cause the data to be lost or the card to be damaged.
- Do not bend the SD Memory Card or subject it to violent impact. Keep it away from water and store away from high temperatures.
- Do not remove the SD Memory Card while formatting. The card may be damaged and become unusable.
- Data on the SD Memory Card may be deleted in the following circumstances. We do not accept any liability for data that is deleted if
 1. the SD Memory Card is mishandled by the user.
 2. the SD Memory Card is exposed to static electricity or electrical interference.
 3. the SD Memory Card has not been used for a long time.
 4. the SD Memory Card or the battery is removed while the card is being accessed.
- If the SD Memory Card is not used for a long time, the data on the card may become unreadable. Be sure to regularly make a backup of important data on a computer.
- Format new SD Memory Cards. Also format SD Memory Cards previously used with other cameras.
- Please note that deleting data stored on an SD Memory Card, or formatting an SD Memory Card does not completely erase the original data. Deleted data can sometimes be recovered using commercially available software. If you are going to discard, give away or sell your SD Memory Card, you should ensure that the data on the card is completely deleted or the card itself is destroyed if it contains any personal or sensitive information.
- The data on your SD Memory Card should be managed at your own risk.

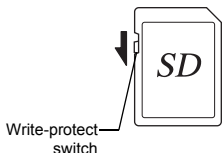

About the Wireless LAN Function

- Do not use the camera in a place where electrical products, AV/OA devices, and so on generate magnetic fields and electromagnetic waves.
- If the camera is affected by magnetic fields and electromagnetic waves, it may not be able to communicate.
- If the camera is used near a TV or a radio, poor reception or TV screen glitch may occur.
- If there are multiple wireless LAN access points near the camera and the same channel is used, search operation may not be executed correctly.
- The security of your data stored, sent or received is your own responsibility.

In the frequency band used by the camera, along with industrial, scientific, and medical devices such as a microwave oven, premises radio stations (wireless stations requiring license) and specified low power radio stations (wireless stations not requiring license) for mobile object identification used in factory production lines, etc., and amateur radio stations (wireless stations requiring license) are operated.

1. Before using the camera, confirm that premises radio stations and specified low power radio stations for mobile object identification and amateur radio stations are not operated in the vicinity.
2. In the event that the camera causes harmful radio wave interference to premises radio stations for mobile object identification, immediately change the frequency being used to avoid interference.
3. If you have other troubles such that the camera causes harmful radio wave interference to specified low power radio stations for mobile object identification or to amateur radio stations, contact your nearest service center.

This camera conforms to the technical standards under the Radio Law and Telecommunications Business Law and the certification of conformance to technical standards can be displayed on the monitor.

The certification marks of conformance to wireless technical standards can be displayed from [Certification Marks] of the 4 menu. Refer to "Using the Menus" (p.19) for how to use the menus.

Trademarks

- Microsoft, Windows, Windows Vista, and Photosynth are registered trademarks of Microsoft Corporation in the United States of America and other countries.
- Macintosh, OS X, QuickTime, iPhone, and App Store are trademarks of Apple Inc., registered in the U.S. and other countries.
- Intel and Intel Core are trademarks of Intel Corporation in the U.S. and/or other countries.
- SDXC Logo is a trademark of SD-3C, LLC.
- Google, Google Play, and Android are trademarks or registered trademarks of Google Inc.
- Wi-Fi is a registered trademark of Wi-Fi Alliance.
- The N-Mark is a trademark or registered trademark of NFC Forum, Inc. in the United States and in other countries.
- iOS is a trademark or registered trademark of Cisco in the U.S. and other countries and is used under license.
- Facebook is a registered trademark of Facebook, Inc.
- Twitter is a registered trademark of Twitter, Inc.
- Tumblr is a registered trademark of Tumblr, Inc.
- This product includes DNG technology under license by Adobe Systems Incorporated.
- The DNG logo is either a registered trademark or trademark of Adobe Systems Incorporated in the United States and/or other countries.
- HDMI, the HDMI logo and High-Definition Multimedia Interface are trademarks or registered trademarks of HDMI Licensing, LLC in the United States and/or other countries.

All other trademarks are the property of their respective owners.

- This product uses the RICOH RT font designed by Ricoh Company Ltd.
 - This product supports PRINT Image Matching III. PRINT Image Matching enabled digital still cameras, printers and software help photographers to produce images more faithful to their intentions. Some functions are not available on printers that are not PRINT Image Matching III compliant.
- Copyright 2001 Seiko Epson Corporation. All Rights Reserved. PRINT Image Matching is a trademark of Seiko Epson Corporation. The PRINT Image Matching logo is a trademark of Seiko Epson Corporation.



AVC Patent Portfolio License

This product is licensed under the AVC Patent Portfolio License for the personal use of a consumer or other uses in which it does not receive remuneration to (i) encode video in compliance with the AVC standard ("AVC video") and/or (ii) decode AVC video that was encoded by a consumer engaged in a personal activity and/or was obtained from a video provider licensed to provide AVC video. No license is granted or shall be implied for any other use.

Additional information may be obtained from MPEG LA, L.L.C.
See <http://www.mpegla.com>.

Announcement on the Use of BSD-Licensed Software

This product includes software licensed under the BSD License. BSD license is a form of license which permits the redistribution of the software provided that it is clearly stated that use is unwarranted, and a copyright notice and a list of licensing conditions are provided. The following contents are displayed based on the abovementioned licensing conditions and are not for the purpose of restricting your use of the product, etc.

Tera Term

Copyright (c) T.Teranishi.

Copyright (c) TeraTerm Project.

All rights reserved.

Redistribution and use in source and binary forms, with or without modification, are permitted provided that the following conditions are met:

1. Redistributions of source code must retain the above copyright notice, this list of conditions and the following disclaimer.
2. Redistributions in binary form must reproduce the above copyright notice, this list of conditions and the following disclaimer in the documentation and/or other materials provided with the distribution.
3. The name of the author may not be used to endorse or promote products derived from this software without specific prior written permission.

THIS SOFTWARE IS PROVIDED BY THE AUTHOR "AS IS" AND ANY EXPRESS OR IMPLIED WARRANTIES, INCLUDING, BUT NOT LIMITED TO, THE IMPLIED WARRANTIES OF MERCHANTABILITY AND FITNESS FOR A PARTICULAR PURPOSE ARE DISCLAIMED. IN NO EVENT SHALL THE AUTHOR BE LIABLE FOR ANY DIRECT, INDIRECT, INCIDENTAL, SPECIAL, EXEMPLARY, OR CONSEQUENTIAL DAMAGES (INCLUDING, BUT NOT LIMITED TO, PROCUREMENT OF SUBSTITUTE GOODS OR SERVICES; LOSS OF USE, DATA, OR PROFITS; OR BUSINESS INTERRUPTION) HOWEVER CAUSED AND ON ANY THEORY OF LIABILITY, WHETHER IN CONTRACT, STRICT LIABILITY, OR TORT (INCLUDING NEGLIGENCE OR OTHERWISE) ARISING IN ANY WAY OUT OF THE USE OF THIS SOFTWARE, EVEN IF ADVISED OF THE POSSIBILITY OF SUCH DAMAGE.

WARRANTY POLICY

All our cameras purchased through authorized bona fide photographic distribution channels are guaranteed against defects of material or workmanship for a period of twelve months from the date of your purchase. Service will be rendered, and defective parts will be replaced without cost to you within that period, provided the camera does not show evidence of impact, sand or liquid damage, mishandling, tampering, battery or chemical corrosion, operation contrary to operating instructions, or modification by an unauthorized repair shop. The manufacturer or its authorized representatives shall not be liable for any repair or alterations except those made with its written consent and shall not be liable for damages from delay or loss of use or from other indirect or consequential damages of any kind, whether caused by defective material or workmanship or otherwise; and it is expressly agreed that the liability of the manufacturer or its representatives under all guarantees or warranties, whether expressed or implied, is strictly limited to the replacement of parts as hereinbefore provided. No refunds will be made on repairs by non-authorized service facilities.

Procedure During 12-month Warranty Period

Any camera which proves defective during the 12-month warranty period should be returned to the dealer from whom you purchased the camera or to the manufacturer. If there are no representatives of the manufacturer in your country, send the camera to the manufacturer, with postage prepaid. In this case, it will take a considerable length of time before the camera can be returned to you owing to the complicated customs procedures required. If the camera is covered by warranty, repairs will be made and parts replaced free of charge, and the

camera will be returned to you upon completion of servicing. If the camera is not covered by warranty, regular charges of the manufacturer or of its representatives will apply. Shipping charges are to be borne by the owner. If your camera was purchased outside of the country where you wish to have it serviced during the warranty period, regular handling and servicing fees may be charged by the manufacturer's representatives in that country. Notwithstanding this, your camera returned to the manufacturer will be serviced free of charge according to this procedure and warranty policy. In any case, however, shipping charges and customs clearance fees to be borne by the sender. To prove the date of your purchase when required, please keep the receipt or bills covering the purchase of your camera for at least a year. Before sending your camera for servicing, please make sure that you are sending it to the manufacturer's authorized representatives or their approved repair shops, unless you are sending it directly to the manufacturer. Always obtain a quotation for the service charge, and only after you accept the quoted service charge, instruct the service station to proceed with the servicing.

- **This warranty policy does not affect the customer's statutory rights.**
- **The local warranty policies available from our distributors in some countries can supersede this warranty policy. Therefore, we recommend that you review the warranty card supplied with your product at the time of purchase, or contact our distributor in your country for more information and to receive a copy of the warranty policy.**

For customers in USA

STATEMENT OF FCC COMPLIANCE

This device complies with Part 15 of the FCC Rules. Operation is subject to the following two conditions: (1) This device may not cause harmful interference, and (2) this device must accept any interference received, including interference that may cause undesired operation.

Changes or modifications not approved by the party responsible for compliance could void the user's authority to operate the equipment.

This equipment has been tested and found to comply with the limits for a Class B digital device, pursuant to part 15 of the FCC Rules.

These limits are designed to provide reasonable protection against harmful interference in a residential installation. This equipment generates, uses and can radiate radio frequency energy and, if not installed and used in accordance with the instructions, may cause harmful interference to radio communications. However, there is no guarantee that interference will not occur in a particular installation.

If this equipment does cause harmful interference to radio or television reception, which can be determined by turning the equipment off and on, the user is encouraged to try to correct the interference by one or more of the following measures:

- Reorient or relocate the receiving antenna.
- Increase the separation between the equipment and receiver.
- Connect the equipment into an outlet on a circuit different from that to which the receiver is connected.

* Consult the dealer or an experienced radio/TV technician for help.

FOR CALIFORNIA, U.S.A. ONLY

Perchlorate Material-special handling may apply.

The lithium battery used in this camera contains perchlorate material, which may require special handling.

See www.dtsc.ca.gov/hazardouswaste/perchlorate

For customers in Canada

Industry Canada (IC) Compliance Notice

This Class B digital apparatus complies with Canadian ICES-003.

This device complies with Industry Canada licence-exempt RSS standard(s). Operation is subject to the following two conditions: (1) this device may not cause interference, and (2) this device must accept any interference, including interference that may cause undesired operation of the device.

Pour les utilisateurs au Canada

Industrie Canada (IC) Avis de Conformité

Cet appareil numérique de la classe B est conforme à la norme NMB-003 du Canada.

Le présent appareil est conforme aux CNR d'Industrie Canada applicables aux appareils radio exempts de licence.

L'exploitation est autorisée aux deux conditions suivantes :

- (1) l'appareil ne doit pas produire de brouillage, et
- (2) l'utilisateur de l'appareil doit accepter tout brouillage radioélectrique subi, même si le brouillage est susceptible d'en compromettre le fonctionnement.

Declaration of Conformity

According to 47CFR, Parts 2 and 15 for
Class B Personal Computers and Peripherals

We: RICOH IMAGING AMERICAS
CORPORATION

Located at: 633 17th Street, Suite 2600
Denver, Colorado 80202 U.S.A.
Phone: 800-877-0155
FAX: 303-790-1131

Declare under sole responsibility that the product identified herein complies with 47CFR Parts 2 and 15 of the FCC rules as a Class B digital device. Each product marketed is identical to the representative unit tested and found to be compliant with the standards. Records maintained continue to reflect the equipment being produced can be expected to be within the variation accepted, due to quantity production and testing on the statistical basis as required by 47CFR §2.909. Operation is subject to the following two conditions: (1) This device may not cause harmful interference, and (2) This device must accept any interference received, including interference that may cause undesired operation. The above named party is responsible for ensuring that the equipment complies with the standards of 47CFR §15.101 to §15.109.

Product Name: SLR Digital Camera
Model Number: PENTAX K-S2
Contact person: Customer Service Manager
Date and Place: January, 2015, Colorado

Information for Users on Collection and Disposal of Old Equipment and Used Batteries



1. In the European Union

These symbols on the products, packaging and/or accompanying documents mean that used electrical and electronic equipment and batteries should not be mixed with general household waste.

Used electrical/electronic equipment and batteries must be treated separately and in accordance with legislation that requires proper treatment, recovery and recycling of these products.



By disposing of these products correctly you will help ensure that the waste undergoes the necessary treatment, recovery and recycling and thus prevent potential negative effects on the environment and human health which could otherwise arise due to inappropriate waste handling.

If a chemical symbol is added beneath the symbol shown above, in accordance with the Battery Directive, this indicates that a heavy metal (Hg = Mercury, Cd = Cadmium, Pb = Lead) is present in the battery at a concentration above an applicable threshold specified in the Battery Directive.

For more information about collection and recycling of used products, please contact your local authorities, your waste disposal service or the point of sale where you purchased the products.

2. In other countries outside the EU

These symbols are only valid in the European Union. If you wish to discard used products, please contact your local authorities or dealer and ask for the correct method of disposal.

For Switzerland: Used electrical/electronic equipment can be returned free of charge to the dealer, even when you don't purchase a new product. Further collection facilities are listed on the home page of www.swico.ch or www.sens.ch.



The CE Mark is a Directive conformity mark of the European Union.

Memo

RICOH IMAGING COMPANY, LTD.

2-35-7, Maeno-cho, Itabashi-ku, Tokyo 174-8639, JAPAN
(<http://www.ricoh-imaging.co.jp>)

RICOH IMAGING EUROPE
S.A.S

112 Quai de Bezons, B.P. 204, 95106 Argenteuil Cedex, FRANCE
(<http://www.ricoh-imaging.fr>)

RICOH IMAGING
DEUTSCHLAND GmbH

Am Kaiserkai 1, 20457 Hamburg, GERMANY
(<http://www.ricoh-imaging.de>)

RICOH IMAGING UK LTD.

PENTAX House, Heron Drive, Langley, Slough, Berks SL3 8PN, U.K.
(<http://www.ricoh-imaging.co.uk>)

RICOH IMAGING AMERICAS
CORPORATION

633 17th Street, Suite 2600, Denver, Colorado 80202, U.S.A.
(<http://www.us.ricoh-imaging.com>)

RICOH IMAGING CANADA
INC.

5520 Explorer Drive Suite 300, Mississauga, Ontario, L4W 5L1, CANADA
(<http://www.ricoh-imaging.ca>)

RICOH IMAGING CHINA CO.,
LTD.

23D, Jun Yao International Plaza, 789 Zhaojiabang Road, Xu Hui District,
Shanghai, 200032, CHINA
(<http://www.ricoh-imaging.com.cn>)

<http://www.ricoh-imaging.co.jp/english>

- Specifications and external dimensions are subject to change without notice.